

# Magnetic surface thermocouple

## For high temperatures

### Model TC52-M

WIKA data sheet TE 66.52

#### Applications

- Tanks
- Reactor shells
- High-pressure and high-temperature reactors
- Coke drums and shells
- Hydrocracker units

#### Special features

- Simplified maintenance and sensor removal without the use of specialised tools
- Maximum surface contact tip design
- High-temperature applications (up to 540 °C [1,000 °F])

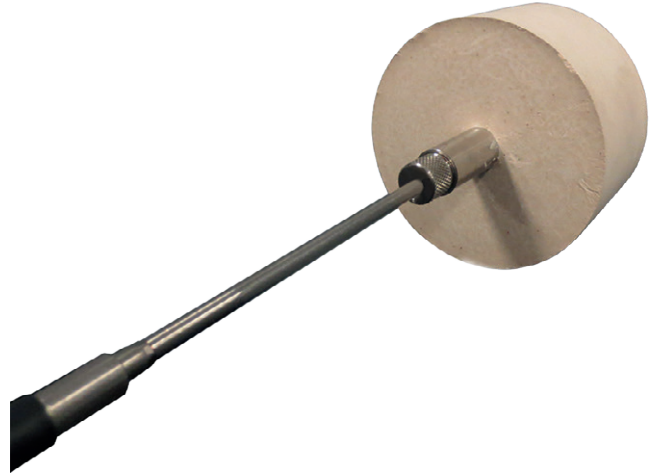

Magnetic surface thermocouple, model TC52-M

#### Description

The magnetic thermocouple is designed as a non-welded option for vessel wall temperature measurement. The circular magnet design incorporates an insulation barrier from radiant heat along with a sensor tip designed to maximise surface contact to ensure accurate temperature measurement.

The neck extension can be manufactured to length based on insulation thickness. The spring-loaded neck extension ensures sensor contact with the vessel wall and allows for maintenance without the use of tools above the insulation/cladding of the vessel.

## Sensor

### Thermocouple per IEC 60584-1 or ASTM E230

Types K, J, E, N, T (single or dual thermocouple)

#### Measuring location

Welded to the bottom (grounded)

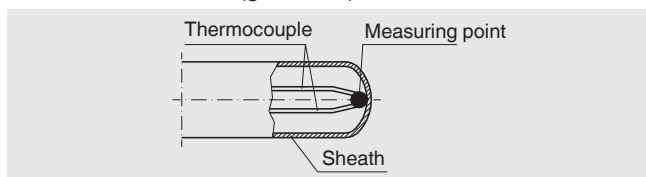

#### Sensor types

Type	Validity limits of the class accuracy		
	IEC 60584-1		ASTM E230
	Class 2	Class 1	Standard / special
<b>K</b>	-40 ... +1,200 °C [-40 ... +2,192 °F]	-40 ... +1,000 °C [-40 ... +1,832 °F]	0 ... 1,260 °C [0 ... 2,300 °F]
<b>J</b>	-40 ... +750 °C [-40 ... +1,382 °F]	-40 ... +750 °C [-40 ... +1,382 °F]	0 ... 760 °C [0 ... 1,400 °F]
<b>E</b>	-40 ... +900 °C [-40 ... +1,652 °F]	-40 ... +800 °C [-40 ... +1,472 °F]	0 ... 870 °C [0 ... 1,598 °F]
<b>N</b>	-40 ... +1,200 °C [-40 ... +2,192 °F]	-40 ... +1,000 °C [-40 ... +1,832 °F]	0 ... 1,260 °C [0 ... 2,300 °F]
<b>T</b>	-40 ... +350 °C [-40 ... +662 °F]	-40 ... +350 °C [-40 ... +662 °F]	0 ... 370 °C [0 ... 698 °F]

The table shows the temperature ranges listed in the respective standards, in which the tolerance values (class accuracies) are valid.

The actual operating temperature of the thermometer is limited both by the maximum permissible working temperature, the diameter of the thermocouple and the sheathed cable, as well as by the maximum permissible working temperature of the sheath material.

For detailed specifications for thermocouples, see IEC 60584-1 or ASTM E230 and Technical information IN 00.23 at [www.wika.com](http://www.wika.com).

#### Cold junction temperature

For the tolerance value of thermocouples, a cold junction temperature of 0 °C [32 °F] has been taken as the basis.

## Minimum and maximum operating temperature

### Process temperature

The process temperature is the temperature which prevails in the area between the probe tip and the process connection. This generally corresponds to the temperatures for which the thermocouple has been defined in accordance with IEC 60584-1 or ASTM E230 standard.

- Sheath material Ni alloy: Alloy 600
  - up to 1,200 °C [2,192 °F] (air)
  - standard material for applications which require specific corrosion-resistant properties under exposure to high temperatures, resistant to induced stress corrosion cracking and pitting corrosion in media containing chloride
  - resistant to corrosion caused by aqueous ammonia in all temperatures and concentrations
  - highly resistant to halogens, chlorine, hydrogen chloride
- Sheath material stainless steel
  - up to 850 °C [1,562 °F] (air)
  - good resistance against aggressive media and also against vapour and combustion gases in chemical media

### Ambient temperature

The area of the transition from MI cable to connection cable (see page 8) and all subsequent components are located in the region of ambient temperature.

If the ambient temperature is higher than the permissible temperature at the cable, connector or transition, the metal parts of the probe must be long enough so that the transition is located outside of the hot zone. At any point on the connection cable, the maximum temperature that may be attained is that for which the connection cable is specified. The probe itself can – within the validity limits of its class accuracy – be loaded higher.

It is important to ensure that the lowest of the maximum permissible ambient temperatures for connection cables, materials used such as sealing compounds in the transition sleeve or a fitted connector or case is not exceeded.

- Maximum temperature at connection housing: 85 °C [185 °F]
- Maximum temperature at connector: 85 °C [185 °F]
- Maximum temperature of the sealing compound at the transition: 250 °C [482 °F]
- Maximum temperature of vibration-resistant versions: 200 °C [392 °F]
- In an optional approval minimum and maximum temperature specified

Other variants on request

For information on the maximum permissible operating temperatures for the connection cable see page 9.

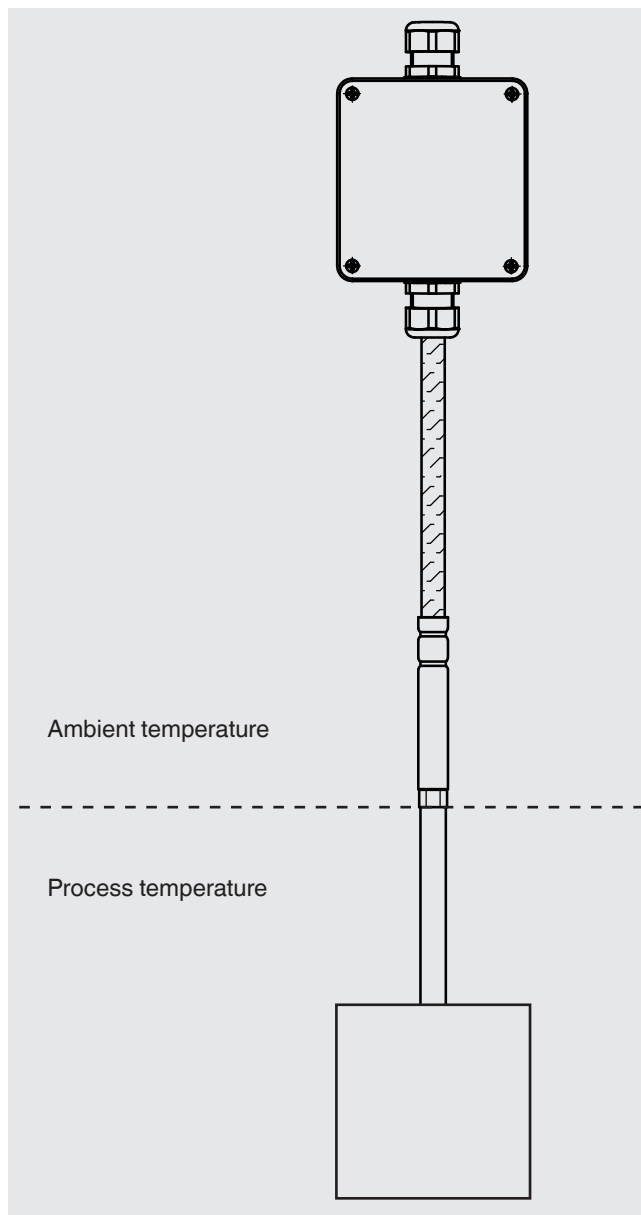

## General design of the TC52-M

In sheathed thermocouples the flexible part of the probe consists of a mineral-insulated cable (MI cable). It features a metal outer sheath, which contains the insulated internal leads, embedded within a high-density ceramic compound.

Due to their flexibility and the small possible diameters, sheathed thermocouples can also be used in locations that are not easily accessible, since, with the exception of the probe tip and the transition sleeve of the connection cable, the sheath can be bent to a radius of five times the diameter of the cable.

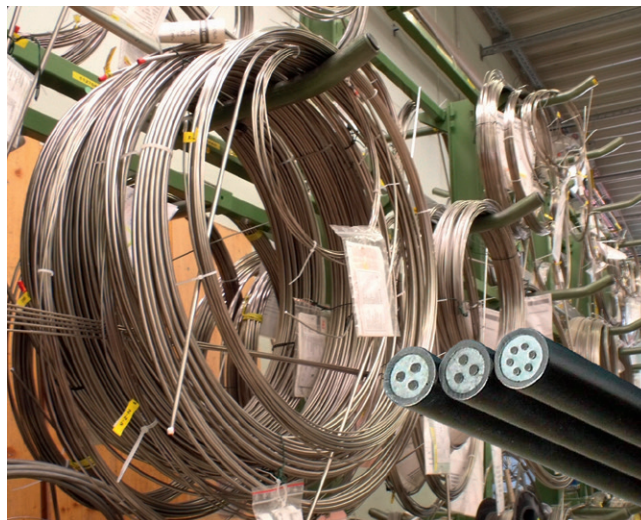

Mineral-insulated cable (MI cable)

# Versions

## ■ With connection cable

Standard version

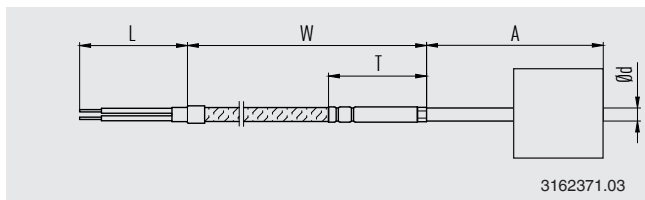

Single wires

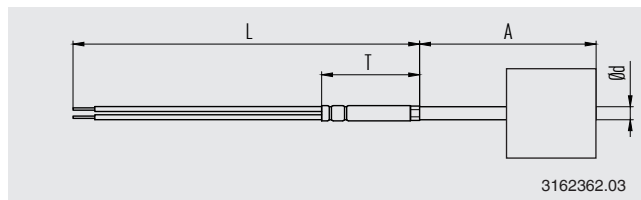

Connection cable with stainless steel braid

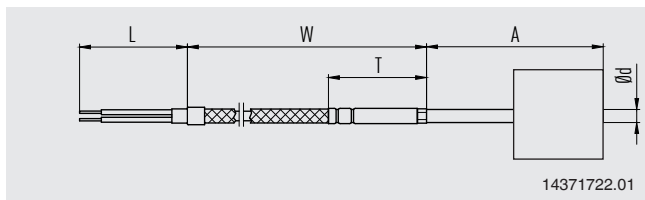

Connection cable with protective metal armoring

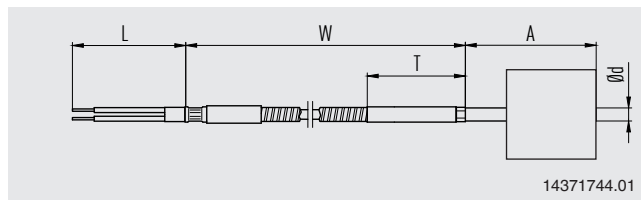

## ■ With connector

Fitted on the MI cable

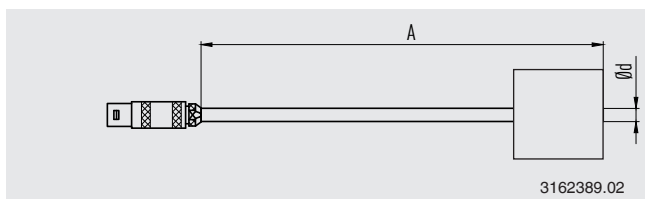

Fitted at the cable end

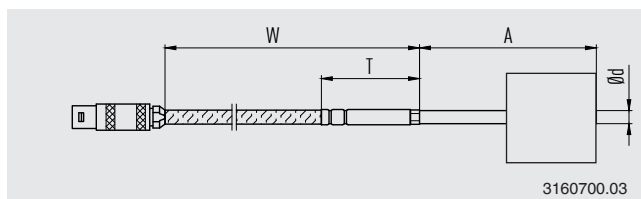

## ■ With connection housing, fitted at the cable end

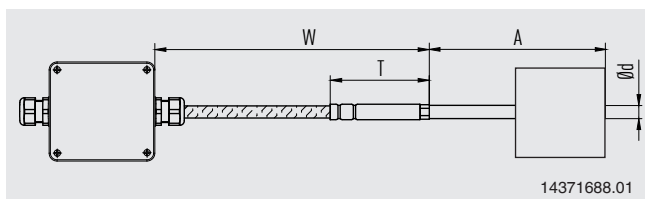

## Angled probes

TC52-M thermocouple can be delivered in a pre-formed shape. In this case, the position of the bend is defined by a further dimension.

Legend:

- X Distance of the bend to the end of the tube
- A Insertion length of the probe (section which is built into the process)

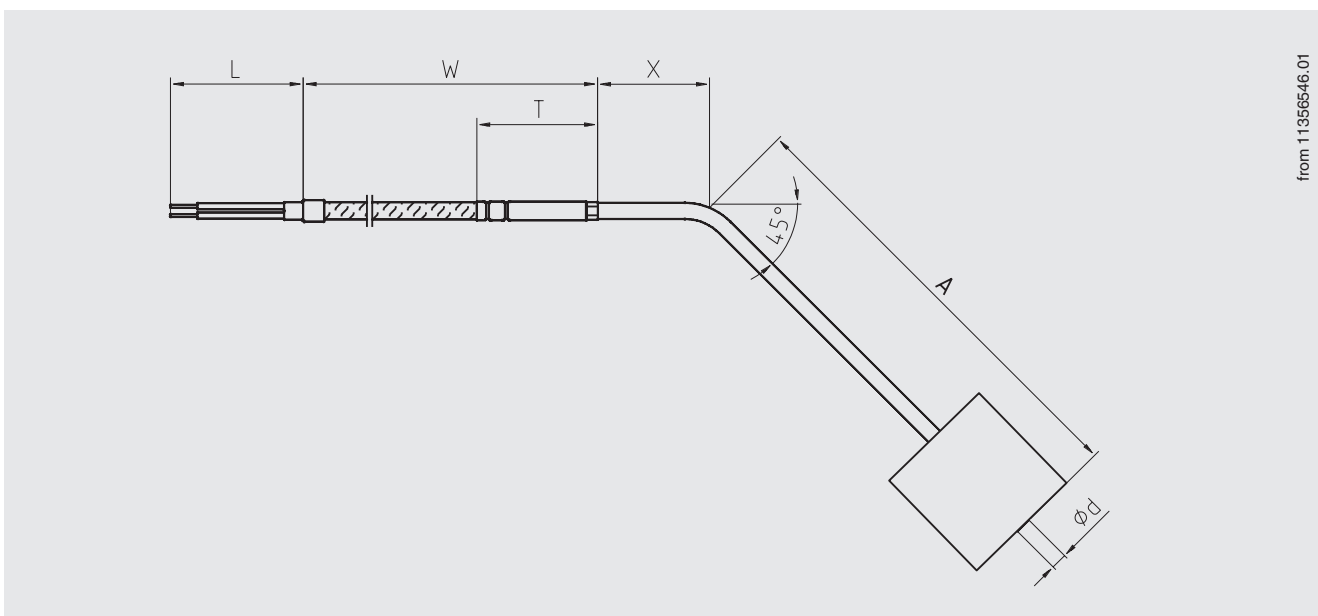
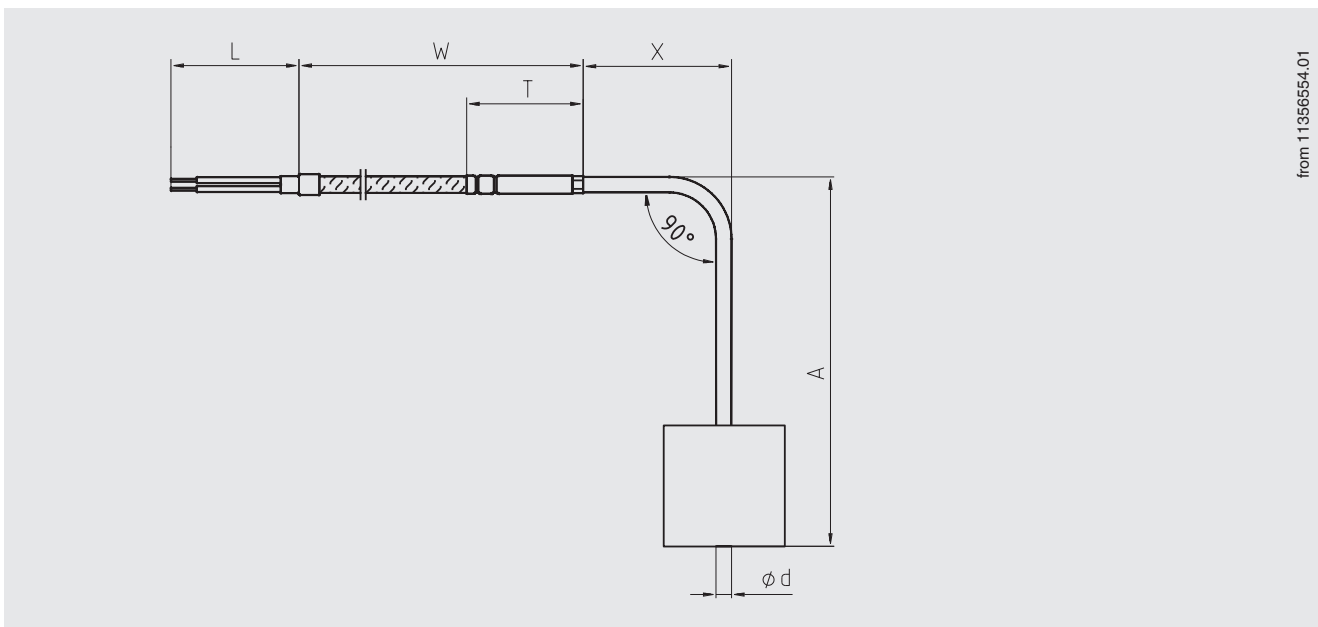

## Process connection

### Spring-loaded magnetic bushing

Specifications	
<b>Applications</b>	<ul style="list-style-type: none"> <li>■ Refinery and chemical industries</li> <li>■ Oil and gas industries</li> <li>■ Offshore exploration and drilling</li> <li>■ Pulp and paper</li> <li>■ Gas plants</li> </ul>
<b>Special features</b>	<ul style="list-style-type: none"> <li>■ High-temperature magnetic material for removable installation of a thermocouple or RTD sensor</li> <li>■ Various neck lengths available on request</li> </ul>
<b>Materials</b>	
Spring-loaded neck assembly	316SS
Insulation material	High temperatures > 600 °C [1,100 °F] MgO base fibre-reinforced Thermal conductivity = 4 BTU-in/°Fhr.Ft <sup>2</sup>
Spring material	High-temperature alloy 600
Magnet material	Alnico 5
<b>Magnet properties</b>	
Holding force (under ambient conditions)	150 lbs [650 N] approximately
Density	0.265 lb/in <sup>3</sup>
Curie temperature	840 °C [1,544 °F]
Maximum practical operating temperature	540 °C [1,000 °F]
Rockwell hardness	Rc50

### Abmessungen in mm [in]

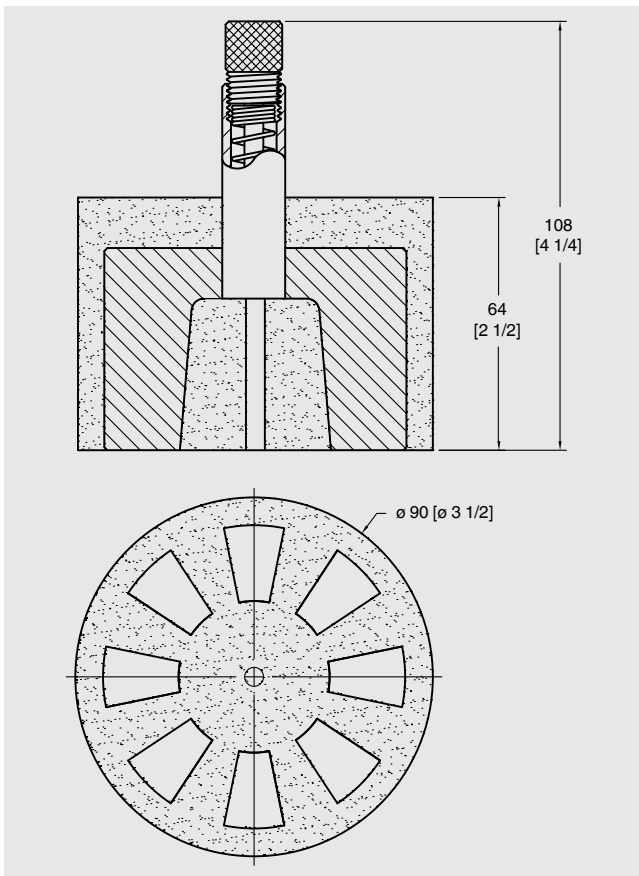

### Packaging and storage

Do not remove packaging until just before mounting. Keep the packaging (keeper) as it will provide optimum protection during transport (e.g. change in installation site). Loss of magnetism can occur if the keeper is not provided. Avoid mechanical shock (putting down hard).

## Transition

### Standard version

The junction between the metal part of the probe and the connection lead or stranded wire must not be bent. Compression fittings should not be attached to the transition sleeve.

The dimensions of the transition sleeve are dependent upon the probe diameter, on the construction of the connection cable and its number of inner conductors - depending on the connection method. Also, operation with ambient temperatures  $< -40\text{ °C}$  [ $-40\text{ °F}$ ] has an influence on the dimensions of the transition sleeve.

## Bend protection

A bend protection (spring or shrink hose) is used to protect the transition point from rigid probe to flexible connection lead. This should always be used when a relative movement between the connection lead and the thermometer mounting is expected.



Bend protection spring



Shrink hose

Both versions should be considered to be technically equivalent with respect to their function as bend protection.



## Connection cable, jacket

Cable jacket	Application range <sup>1)</sup>
PTFE/PFA	-60 ... +250 °C [-76 ... +482 °F]
PTFE/PFA, shielded (see standard versions below)	-60 ... +250 °C [-76 ... +482 °F]
Single wires, PTFE/PFA	-60 ... +250 °C [-76 ... +482 °F]
Stainless steel braid over PTFE/PFA	-60 ... +250 °C [-76 ... +482 °F]
Silicone	-50 ... +180 °C [-58 ... +356 °F]
Silicone, shielded (see standard versions below)	-50 ... +180 °C [-58 ... +356 °F]
PVC	-20 ... +100 °C [-4 ... +212 °F]
Fibreglass	-50 ... +400 °C [-58 ... +752 °F]
Stainless steel braid over fibreglass	-50 ... +400 °C [-58 ... +752 °F]
Protective metal armouring over PTFE/PFA	-60 ... +250 °C [-76 ... +482 °F]
Protective metal armouring with PTFE/PFA sheath over PTFE/PFA	-60 ... +250 °C [-76 ... +482 °F]
Protective metal armouring with PVC sheath over PVC	-20 ... +100 °C [-4 ... +212 °F]
Protective metal armouring with PE sheath over PTFE/PFA	-50 ... +250 °C [-58 ... +482 °F]

1) Minimum/Maximum temperatures valid for stationary cable. The actual operating temperature (process temperature) of the thermometer can deviate.

### Colour code of cable

Sensor type	Standard	Thermocouple cable, compensating cable		
		Outer sheath	Positive	Negative
K	IEC 60584-3	Green	Green	White
J	IEC 60584-3	Black	Black	White
E	IEC 60584-3	Violet	Violet	White
T	IEC 60584-3	Brown	Brown	White
N	IEC 60584-3	Pink	Pink	White

Sensor type	Standard	Thermocouple cable			Compensating cable		
		Outer sheath	Positive	Negative	Outer sheath	Positive	Negative
K	ASTM E230	Brown	Yellow	Red	Yellow	Yellow	Red
J	ASTM E230	Brown	White	Red	Black	White	Red
E	ASTM E230	Brown	Violet	Red	Violet	Violet	Red
T	ASTM E230	Brown	Blue	Red	Blue	Blue	Red
N	ASTM E230	Brown	Orange	Red	Orange	Orange	Red

For further information on colour coding, see Technical information IN 00.23 at [www.wika.com](http://www.wika.com).

### Standard cable lengths

Metric lengths

- 1,000 mm
- 2,000 mm
- 3,000 mm
- 5,000 mm

Imperial lengths

- 24 in
- 36 in
- 72 in
- 144 in

Other cable lengths are possible

**Standard versions of the shield electrical connection**

- Shield not connected at the sensor, stripped lead at the end of the cable
  - Shield connected at the sensor, stripped lead at the end of the cable
  
  - Shield not connected at the sensor, connected at the housing
  - Shield connected at the sensor, connected at the case
  
  - Shield not connected at the sensor, connected at the connector
  - Shield connected at the sensor, connected at the connector
  - Shield connected at the sensor, not connected at the connector
- Other versions on request

**Design of the lead ends**

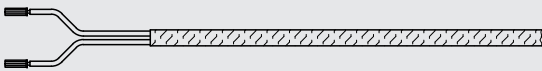
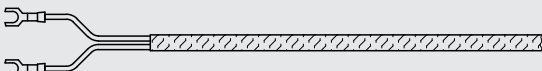
Version	Illustration
Flying leads	
End splices	
Spade lugs (fork design)	

**Cord grip**

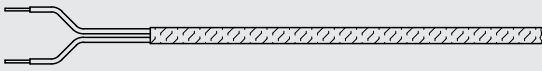
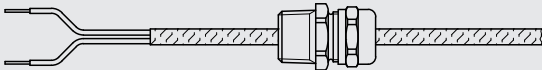
Thread size	Material	Illustration
Without	-	
M16 x 1.5	Plastic	
M20 x 1.5	Plastic	
1/2 NPT	Plastic	
1/2 NPT	Metal	
3/4 NPT	Metal	

## Connection housing (option)

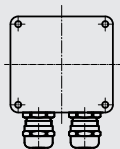
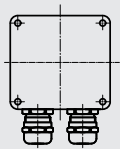

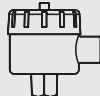
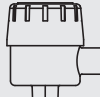
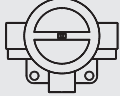
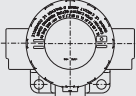
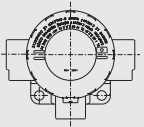

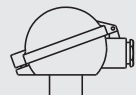
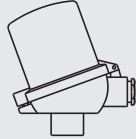
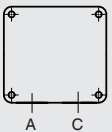
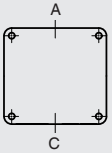
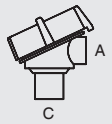
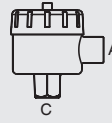
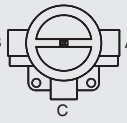
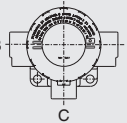

Illustration	Model	Material	Cable entry thread size	Cover	Surface	Other
	Field case	Plastic (ABS)	<ul style="list-style-type: none"> <li>■ M12 x 1.5</li> <li>■ 1/2 NPT</li> <li>■ M16 x 1.5</li> </ul>	Flat cover with 4 plug screws	Grey	<ul style="list-style-type: none"> <li>■ 82 x 80 x 55 mm [3.2 x 3.1 x 2.2 in] (L x W x H)</li> <li>■ Inputs on one side</li> </ul>
	Field case	Aluminium	<ul style="list-style-type: none"> <li>■ M12 x 1.5</li> <li>■ 1/2 NPT</li> <li>■ M16 x 1.5</li> </ul>	Flat cover with 4 plug screws	Natural finish	<ul style="list-style-type: none"> <li>■ 80 x 75 x 57 mm [3.1 x 2.9 x 2.3 in] (L x W x H)</li> <li>■ Inputs on one side</li> </ul>
	Field case	Plastic (ABS)	<ul style="list-style-type: none"> <li>■ M12 x 1.5</li> <li>■ 1/2 NPT</li> <li>■ M16 x 1.5</li> </ul>	Flat cover with 4 plug screws	Grey	<ul style="list-style-type: none"> <li>■ 82 x 80 x 55 mm [3.2 x 3.1 x 2.2 in] (L x W x H)</li> <li>■ Inputs opposite each other</li> </ul>
	Field case	Aluminium	<ul style="list-style-type: none"> <li>■ M12 x 1.5</li> <li>■ 1/2 NPT</li> <li>■ M16 x 1.5</li> </ul>	Flat cover with 4 plug screws	Natural finish	<ul style="list-style-type: none"> <li>■ 80 x 75 x 57 mm [3.1 x 2.9 x 2.3 in] (L x W x H)</li> <li>■ Inputs opposite each other</li> </ul>
	1/4000	Aluminium	<ul style="list-style-type: none"> <li>■ M20 x 1.5</li> <li>■ 1/2 NPT</li> <li>■ 3/4 NPT</li> </ul>	Screw-on lid	Blue, painted <sup>1)</sup>	-
	1/4000	Stainless steel	<ul style="list-style-type: none"> <li>■ M20 x 1.5</li> <li>■ 1/2 NPT</li> <li>■ 3/4 NPT</li> </ul>	Screw-on lid	Natural finish	-
	7/8000	Aluminium	<ul style="list-style-type: none"> <li>■ M20 x 1.5</li> <li>■ 1/2 NPT</li> <li>■ 3/4 NPT</li> </ul>	Screw-on lid	Blue, painted <sup>1)</sup>	-
	7/8000	Stainless steel	<ul style="list-style-type: none"> <li>■ M20 x 1.5</li> <li>■ 1/2 NPT</li> <li>■ 3/4 NPT</li> </ul>	Screw-on lid	Natural finish	-
	7/8000	Aluminium	<ul style="list-style-type: none"> <li>■ M20 x 1.5</li> <li>■ 1/2 NPT</li> <li>■ 3/4 NPT</li> </ul>	Screw-on lid, with digital temperature display, model DIH50-B	Blue, painted <sup>1)</sup>	-
	7/8000	Stainless steel	<ul style="list-style-type: none"> <li>■ M20 x 1.5</li> <li>■ 1/2 NPT</li> <li>■ 3/4 NPT</li> </ul>	Screw-on lid, with digital temperature display, model DIH50-B	Natural finish	-
	5/6000	Aluminium	<ul style="list-style-type: none"> <li>■ 2 x M20 x 1.5</li> <li>■ 2 x 1/2 NPT</li> <li>■ 2 x 3/4 NPT</li> </ul>	Screw-on lid	Blue, painted <sup>1)</sup>	-
	5/6000	Stainless steel	<ul style="list-style-type: none"> <li>■ 2 x M20 x 1.5</li> <li>■ 2 x 1/2 NPT</li> <li>■ 2 x 3/4 NPT</li> </ul>	Screw-on lid	Natural finish	-
	5/6000	Aluminium	<ul style="list-style-type: none"> <li>■ 2 x M20 x 1.5</li> <li>■ 2 x 1/2 NPT</li> <li>■ 2 x 3/4 NPT</li> </ul>	Screw-on lid, with digital temperature display, model DIH50-B	Blue, painted <sup>1)</sup>	-
	5/6000	Stainless steel	<ul style="list-style-type: none"> <li>■ 2 x M20 x 1.5</li> <li>■ 2 x 1/2 NPT</li> <li>■ 2 x 3/4 NPT</li> </ul>	Screw-on lid, with digital temperature display, model DIH50-B	Natural finish	-

Illustration	Model	Material	Cable entry thread size	Cover	Surface	Other
	Field transmitter TIF50	Aluminium	<ul style="list-style-type: none"> <li>■ 2 x M20 x 1.5</li> <li>■ 2 x 1/2 NPT</li> <li>■ 2 x 3/4 NPT</li> </ul>	Screw-on lid, with digital temperature display, model DIH50-B	Blue, painted <sup>1)</sup>	-
	Field transmitter TIF50	Stainless steel	<ul style="list-style-type: none"> <li>■ 2 x M20 x 1.5</li> <li>■ 2 x 1/2 NPT</li> <li>■ 2 x 3/4 NPT</li> </ul>	-	Natural finish	-
	Field transmitter TIF52	Aluminium	<ul style="list-style-type: none"> <li>■ 2 x M20 x 1.5</li> <li>■ 2 x 1/2 NPT</li> <li>■ 2 x 3/4 NPT</li> </ul>	-	-	-
	Field transmitter TIF52	Stainless steel	<ul style="list-style-type: none"> <li>■ 2 x M20 x 1.5</li> <li>■ 2 x 1/2 NPT</li> <li>■ 2 x 3/4 NPT</li> </ul>	-	-	-
	KN4-A	Aluminium	<ul style="list-style-type: none"> <li>■ M20 x 1.5</li> <li>■ 1/2 NPT</li> <li>■ 3/4 NPT</li> </ul>	Screw-on lid	Blue, painted <sup>1)</sup>	-
	KN4-P	Polypropylene	<ul style="list-style-type: none"> <li>■ M20 x 1.5</li> <li>■ 1/2 NPT</li> <li>■ 3/4 NPT</li> </ul>	Screw-on lid	White	-
	BSZ	Aluminium	<ul style="list-style-type: none"> <li>■ M20 x 1.5</li> <li>■ 1/2 NPT</li> </ul>	Spherical, hinged cover with plug screw	Blue, painted <sup>1)</sup>	-
	BSZ-H	Aluminium	<ul style="list-style-type: none"> <li>■ M20 x 1.5</li> <li>■ 1/2 NPT</li> </ul>	High hinged cover with plug screw	Blue, painted <sup>1)</sup>	-

1) RAL 5022

### Position of the probe input

The standard probe input is located at position C.  
 Another position for the probe input is possible as an option.

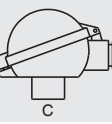
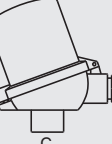
Illustration	Connection housing
	Field case with inputs on either side
	Field case with inputs on opposite sides
	Connection housing 1/4000
	Connection housing 7/8000 Connection housing 7/8000 with DIH50
	Connection housing 5/6000
	Connection housing 5/6000 with DIH50-B Field transmitter TIF50/TIF52
	Connection head KN4-A
	Connection head BSZ
	Connection head BSZ-H

## Cable entry

Cable entry	Colour	Ingress protection (max.) IEC/EN 60529	Cable entry thread size	Min./max. ambient temperature
 <b>Standard cable entry</b>	Natural finish	IP65	<ul style="list-style-type: none"> <li>■ M20 x 1.5</li> <li>■ ½ NPT</li> </ul>	-40 ... +80 °C [-40 ... +176 °F]
 <b>Plastic cable gland (cable Ø 6 ... 10 mm)</b>	Black or grey	IP66 <sup>1)</sup>	<ul style="list-style-type: none"> <li>■ M20 x 1.5</li> <li>■ ½ NPT</li> </ul>	-40 ... +80 °C [-40 ... +176 °F]
 <b>Plastic cable gland (cable Ø 6 ... 10 mm), Ex e</b>	Light blue or black	IP66 <sup>1)</sup>	<ul style="list-style-type: none"> <li>■ M20 x 1.5</li> <li>■ ½ NPT</li> </ul>	<ul style="list-style-type: none"> <li>■ -20 ... +80 °C [-4 ... +176 °F]</li> <li>■ -40 ... +70 °C [-40 ... +158 °F]</li> </ul>
 <b>Nickel-plated brass cable gland (cable Ø 6 ... 12 mm)</b>	Natural finish	IP66 <sup>1)</sup>	<ul style="list-style-type: none"> <li>■ M20 x 1.5</li> <li>■ ½ NPT</li> </ul>	-60 <sup>2)</sup> / -40 ... +80 °C [-76 <sup>2)</sup> / -40 ... +176 °F]
	Natural finish	IP66 <sup>1)</sup>	<ul style="list-style-type: none"> <li>■ M20 x 1.5</li> <li>■ ½ NPT</li> </ul>	-60 <sup>2)</sup> / -40 ... +80 °C [-76 <sup>2)</sup> / -40 ... +176 °F]
 <b>Stainless steel cable gland (cable Ø 7 ... 12 mm)</b>	Natural finish	IP66 <sup>1)</sup>	<ul style="list-style-type: none"> <li>■ M20 x 1.5</li> <li>■ ½ NPT</li> </ul>	-60 <sup>2)</sup> / -40 ... +80 °C [-76 <sup>2)</sup> / -40 ... +176 °F]
	Natural finish	IP66 <sup>1)</sup>	<ul style="list-style-type: none"> <li>■ M20 x 1.5</li> <li>■ ½ NPT</li> </ul>	-60 <sup>2)</sup> / -40 ... +80 °C [-76 <sup>2)</sup> / -40 ... +176 °F]
 <b>Plain threaded</b>	-	IP00	<ul style="list-style-type: none"> <li>■ M20 x 1.5</li> <li>■ ½ NPT</li> </ul>	-
 <b>2 x plain threaded <sup>3)</sup></b>	-	IP00	<ul style="list-style-type: none"> <li>■ 2 x M20 x 1.5</li> <li>■ 2 x ½ NPT</li> </ul>	-
 <b>Junction box M12 x 1 (4-pin) <sup>4)</sup></b>	-	IP65	M20 x 1.5	-40 ... +80 °C [-40 ... +176 °F]
 <b>Sealing plugs for shipping</b>	Transparent	-	<ul style="list-style-type: none"> <li>■ M20 x 1.5</li> <li>■ ½ NPT</li> </ul>	-40 ... +80 °C [-40 ... +176 °F]

The figures show examples of connection heads.

1) Only for BSZ-H connection head

2) Not available for ½ NPT thread size cable entry

3) Special version on request (only available with selected approvals), other temperatures on request

4) Ignition protection types, describing temporary or permanent immersion, on request

## Transmitter built into the connection housing (option)

A transmitter can be mounted in an optional connection housing.

**HART**  
COMMUNICATION PROTOCOL



Output signal 4 ... 20 mA and HART® protocol		
Transmitter (selectable versions)	Model T16	Model T32
Data sheet	TE 16.01	TE 32.04
<b>Output</b>		
4 ... 20 mA	x	x
HART® protocol	-	x
<b>Explosion protection</b>	Optional	Optional

For detailed specifications on the explosion protection of the transmitter, see respective transmitter data sheet.

## Accessories, connection housing

Pipe-mounting kit, stainless steel (for field case)

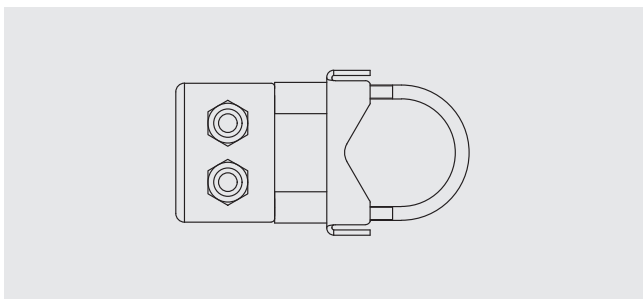

Pipe-mounting kit, stainless steel (for 5/6000, DIH50/DIH52, TIF50/TIF52)

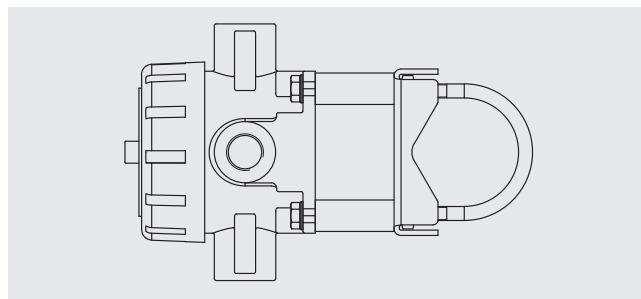

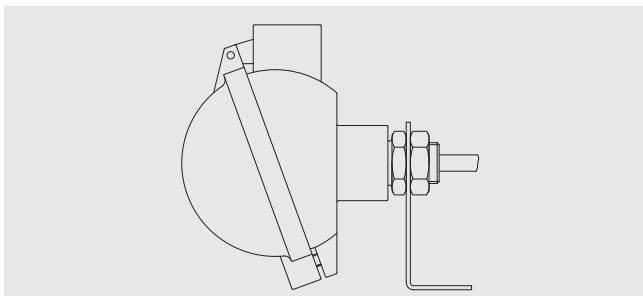

Fixing bracket (for wall mounting) 92 x 60 x 50 mm  
[3.6 x 2.4 x 2.0 in], stainless steel (for connection head models BSZ and BSZ-H)

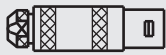

## Connector (option)

Cable thermocouples can be supplied with connectors fitted.  
The following options are available:

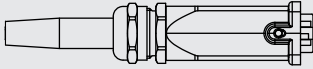
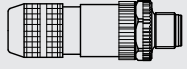
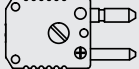
Illustration	Model
	Lemos connector (male)
	Binder/Amphenol screw/plug-in connector (male)
	Harting connector (male)
	Binder screw/plug-in connector, M12 x 1 (male)
	Thermo-connector (male)

The figures are not to scale.



## Ingress protection per IEC/EN 60529

### Ingress protection against solid foreign bodies (defined by the 1st index number)

First index number	Short description	Test parameters
5	Dust-protected	per IEC/EN 60529
6	Dust-tight	per IEC/EN 60529

### Ingress protection against water (defined by the 2nd index number)

Second index number	Short description	Test parameters
4	Protected against splash water	per IEC/EN 60529
5	Protected against water jets	per IEC/EN 60529
6	Protected against strong water jets	per IEC/EN 60529
7	Protected against the effects of temporary immersion in water	per IEC/EN 60529
8	Protected against the effects of permanent immersion in water	as agreed upon

Model TC52-M is available in the following IP ingress protection:

- IP40
- IP50
- IP54 (standard)
- IP65
- IP67

The specified ingress protection apply under the following conditions:

- Use of a suitable cable gland
- Use of a cable cross-section appropriate for the gland or select the appropriate cable gland for the available cable
- Adhere to the tightening torques for all threaded connections

### Classification of the IP protection zones of the probe

- Version with connection cable

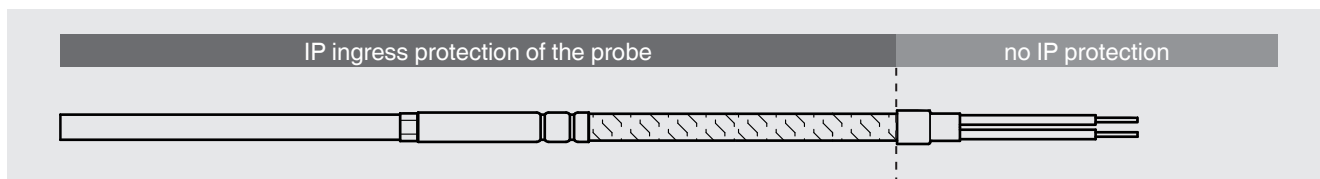

- Version with connection housing, fitted at the cable end

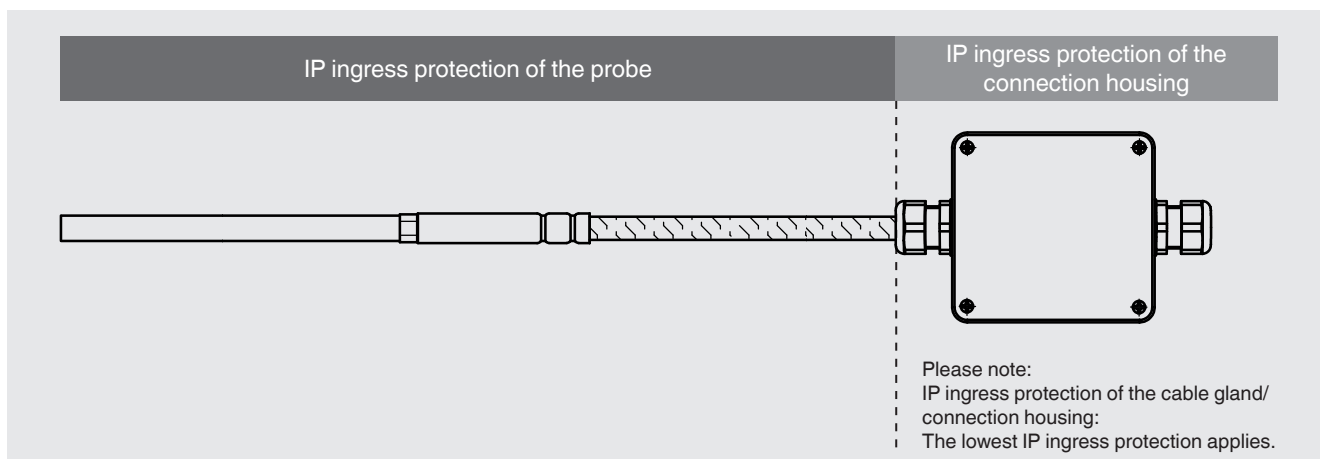

- Version with connector, fitted at the cable end

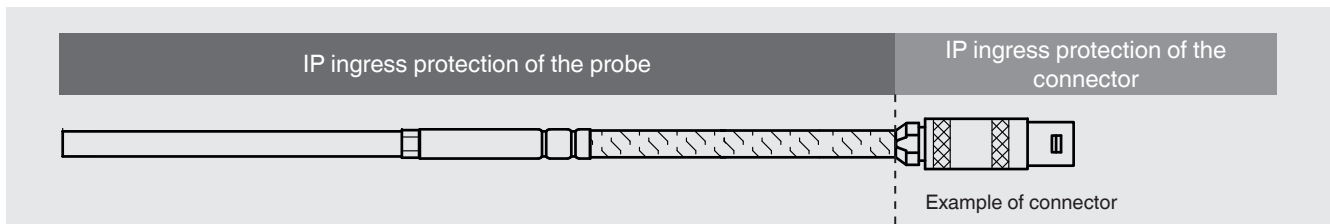

- Version with connector, fitted at the MI cable

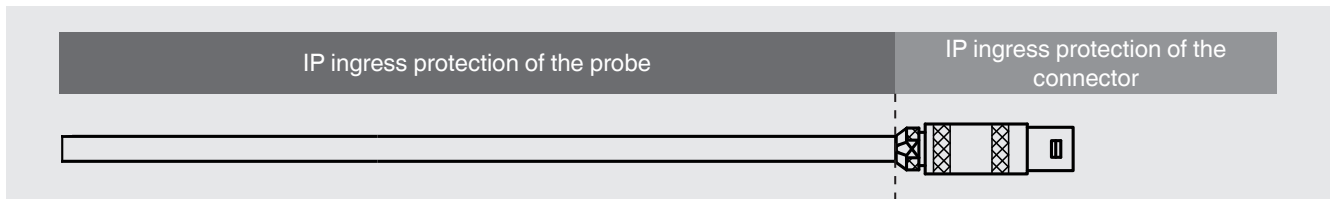

### IP ingress protection types of the connection housing

Connection housing	Version	IP ingress protection
Field case	Plastic (ABS) / aluminium	IP65
Connection head	KN4-A	IP65
	KN4-P	
	BSZ	
	BSZ-H	
	1/4000	IP66
	5/6000	
	5/6000 with DIH50	
7/8000	IP66	
7/8000 with DIH50		
Field transmitter	TIF50/TIF52	IP66

### IP ingress protection types of the connector

Connector	Version	IP ingress protection
Binder	Series 680	IP40
	Series 692	
	Series 423	
Amphenol	C16-3	IP40
Lemosa	Size 0 S	IP50
	Size 1 S	
	Size 2 S	
	Size 1 E	IP65
Harting	7D	IP65
	8D	
	8U	
M12 x 1	4-pin	IP65
Thermo-connector	2-pin, standard/miniature	IP00
	3-pin, standard/miniature	

# Electrical connection

## Without connector

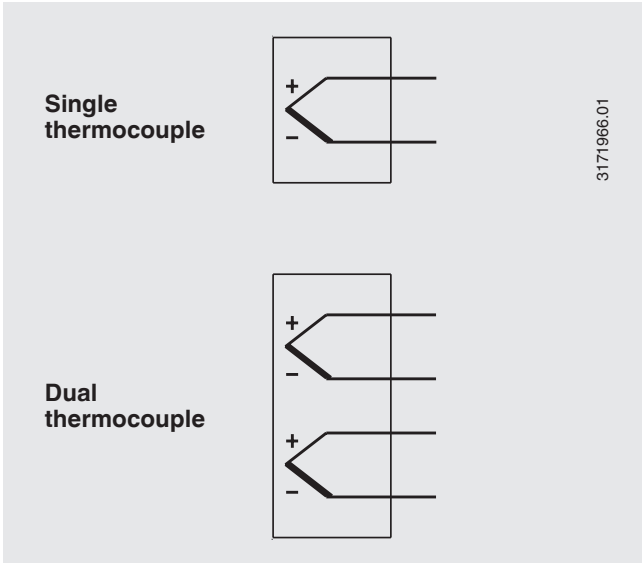

## Lemosa connector

max. permissible temperature range: -55 ... +250 °C  
[-67... +482 °F]

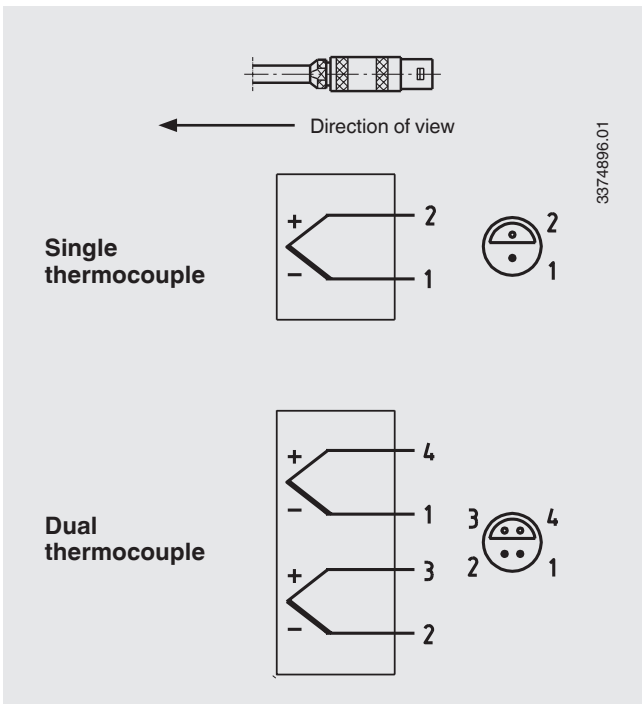

## Screw/plug-in connector (Amphenol, Binder) Series 680, series 423 (shielded)

max. permissible temperature range: -40 ... +85 °C  
[-40 ... +185 °F]

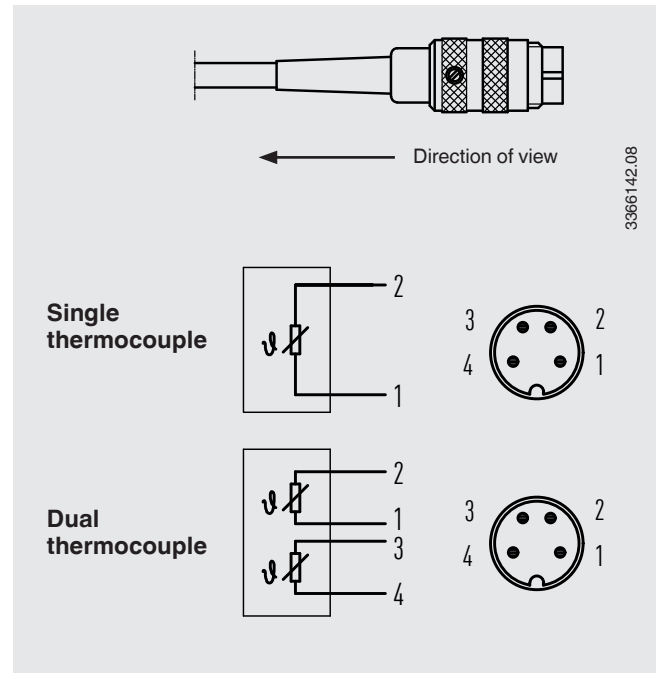

### Thermo-connector (male)

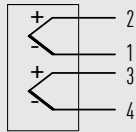
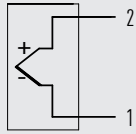
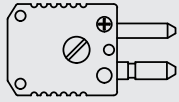

Positive and negative terminal are marked.  
Two thermo-connectors are used with dual thermocouples.

14372358.01

### Binder screw/plug-in connector (male), M12 x 1 (series 713)

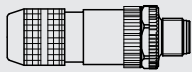

← Direction of view

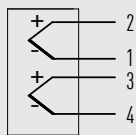
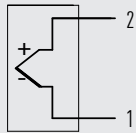

14372219.01

### Harting connector

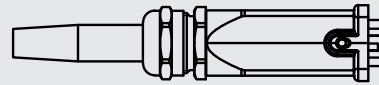

← Direction of view

ATTENTION: Pin assignment for version "WIKA standard"!

Contact insert pins

Contact insert socket

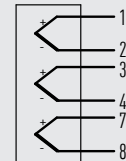
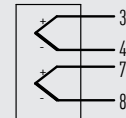
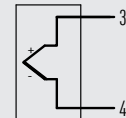
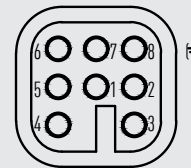
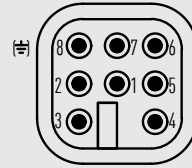

14372213.01

### Ceramic terminal block

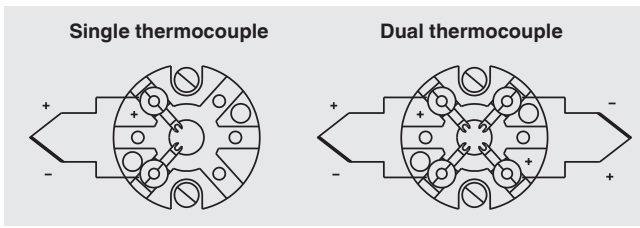

### Crastin terminal block

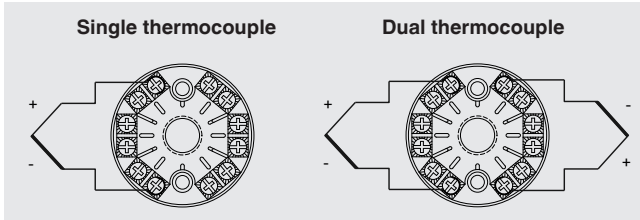

The colour coding at the positive connection to the instruments always decides the correlation of polarity and connection terminal.

For the electrical connections of built-in temperature transmitters see the corresponding data sheets or operating instructions.

### Rack-mounting terminals

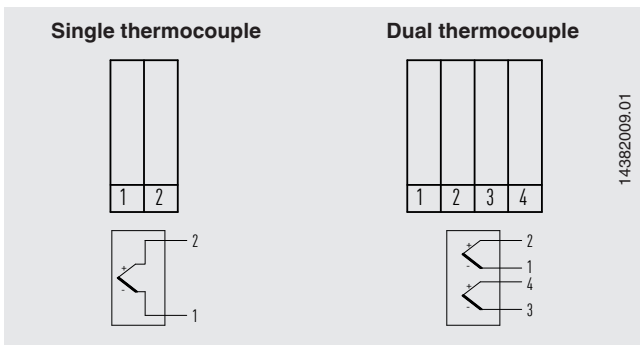

## Operating conditions

### Mechanical requirements

Version	
Standard	max. 50 g peak-to-peak, 10 ... 500 Hz

The information on vibration resistance refers to the probe tip.

### Storage temperature

-40 ... +80 °C [-40 ... +176 °F]

Other storage temperatures on request

## Shipping information

Model TC52-M thermocouple in "straight" version, with lengths > 1,100 mm [43.31 in] is wound and delivered in coils.

## Certificates (option)

Certification type	Measurement accuracy	Material certificate
2.2 test report	x	x
3.1 inspection certificate	x	x
DAkkS calibration certificate	x	-

The different certifications can be combined with each other.

The thermometer is immersed in a calibrator without process connection.

## Ordering information

Model / Explosion protection / Probe version / Threaded connection version / Thread size / Materials / Probe diameter / Measuring element / Connection method / Temperature range / Connection cable, jacket / Lead ends version / Certificates / Options

© 11/2021 WIKA Alexander Wiegand SE & Co. KG, all rights reserved.  
The specifications given in this document represent the state of engineering at the time of publishing.  
We reserve the right to make modifications to the specifications and materials.

