

Cable resistance thermometer

Tubular design

Model TR41

WIKA data sheet TE 60.41



for further approvals
see page 2

Applications

- For direct installation into the process
- Machine building
- Motors
- Bearings

Special features

- Sensor ranges from -50 ... +250 °C [-58 ... +482 °F]
- For insertion or screw-in with optional process connection
- Cable from PTFE, PFA, silicone and other cable sheath materials
- Versions with/without connector or connection housing (option)
- Explosion-protected versions are available for many approval types (see page 2)



Cable resistance thermometer, model TR41

Description

Cable resistance thermometers are particularly suited to those applications in which the metallic probe tip is mounted directly into bored holes (e.g. in machine components) or directly into the process, and for any application with no chemically aggressive media or abrasion.

A large number of different explosion protection approvals are available for the TR41.

For mounting into a thermowell, a spring-loaded compression fitting should be provided, since only this can press the measuring tip into the bottom of the thermowell. Otherwise a potentially critical force could be exerted on the measuring tip.

In the standard version the cable probes are manufactured without process connections. Fastening elements such as threaded connections, compression fittings, etc. are possible as options.





Explosion protection (option)



The permissible power, P_{max} , as well as the permissible ambient temperature, for the respective category can be seen on the certificate for hazardous areas or in the operating instructions.

The internal inductance ($L_i = 1 \mu\text{H/m}$) and capacitance ($C_i = 200 \text{ pF/m}$) for cable probes should be taken into account when connecting to an intrinsically safe voltage supply.

Transmitters have own certificates for hazardous areas. The permissible ambient temperature ranges of the built-in transmitters can be taken from the corresponding transmitter operating instructions and approvals.

Approvals (explosion protection, further approvals)

Logo	Description	Region
 	EU declaration of conformity <ul style="list-style-type: none"> ■ EMC directive ¹⁾ EN 61326 emission (group 1, class B) and immunity (industrial application) ■ RoHS directive ■ ATEX directive (option) Hazardous areas <ul style="list-style-type: none"> - Ex i Zone 0 gas II 1G Ex ia IIC T1 ... T6 Ga Zone 1 mounting to zone 0 gas II 1/2G Ex ia IIC T1 ... T6 Ga/Gb Zone 1 gas II 2G Ex ia IIC T1 ... T6 Gb Zone 20 dust II 1D Ex ia IIIC T125 ... T65 °C Da Zone 21 mounting to zone 20 dust II 1/2D Ex ia IIIC T125 ... T65 °C Da/Db Zone 21 dust II 2D Ex ia IIIC T125 ... T65 °C Db - Ex e ²⁾ Zone 1 gas II 2G Ex eb IIC T1 ... T6 Gb ⁴⁾ Zone 2 gas II 3G Ex ec IIC T1 ... T6 Gc X Zone 21 dust II 2D Ex tb IIIC TX °C Db ⁴⁾ Zone 22 dust II 3D Ex tc IIIC TX °C Dc X - Ex n ²⁾ Zone 2 gas II 3G Ex nA IIC T1 ... T6 Gc X Zone 22 dust II 3D Ex tc IIIC TX °C Dc X 	European Union
 	IECEx (option) - in conjunction with ATEX Hazardous areas <ul style="list-style-type: none"> - Ex i Zone 0 gas Ex ia IIC T1 ... T6 Ga Zone 1 mounting to zone 0 gas Ex ia IIC T1 ... T6 Ga/Gb Zone 1 gas Ex ia IIC T1 ... T6 Gb Zone 20 dust Ex ia IIIC T125 ... T65 °C Da Zone 21 mounting to zone 20 dust Ex ia IIIC T125 ... T65 °C Da/Db Zone 21 dust Ex ia IIIC T125 ... T65 °C Db - Ex e ³⁾ Zone 1 gas Ex eb IIC T1...T6 Gb ⁴⁾ Zone 2 gas Ex ec IIC T1...T6 Gc Zone 21 dust Ex tb IIIC TX °C Db ⁴⁾ Zone 22 dust Ex tc IIIC TX °C Dc - Ex n ³⁾ Zone 2 gas Ex nA IIC T1...T6 Gc Zone 22 dust Ex tc IIIC TX °C Dc 	International
	INMETRO (option) Hazardous areas <ul style="list-style-type: none"> - Ex i Zone 0 gas Ex ia IIC T3 ... T6 Ga Zone 1 mounting to zone 0 gas Ex ia IIC T3 ... T6 Ga/Gb Zone 20 dust Ex ia IIIC T125 ... T65 °C Da Zone 21 mounting to zone 20 dust Ex ia IIIC T125 ... T65 °C Da/Db 	Brazil

Logo	Description	Region
	CCC (option) ⁴⁾ Hazardous areas - Ex i Zone 0 gas Ex ia IIC T1 ~ T6 Ga Zone 1 gas Ex ia IIC T1 ~ T6 Gb Zone 1 mounting to zone 0 gas Ex ia IIC T1 ~ T6 Ga/Gb Zone 1 gas Ex ic IIC T1 ~ T6 Gc Zone 20 dust Ex iaD 20 T65/T95/T125 °C Zone 21 dust Ex iaD 21 T65/T95/T125 °C Zone 21 mounting to zone 20 dust Ex iaD 20/21 T65/T95/T125 °C - Ex e ³⁾ Zone 1 gas Ex eb IIC T1 ~ T6 Gb ⁴⁾ Zone 2 gas Ex ec IIC T1 ~ T6 Gc - Ex n Zone 2 gas Ex nA IIC T1 ~ T6 Gc - Ex tD Zone 22 mounting to zone 21 dust Ex tD A21/A22 IP66 T135 °C	China
	NEPSI (option) Hazardous areas - Ex i Zone 0 gas Ex ia IIC T1 ~ T6 Ga Zone 1 gas Ex ia IIC T1 ~ T6 Gb Zone 1 mounting to zone 0 gas Ex ia IIC T1 ~ T6 Ga/Gb Zone 1 gas Ex ic IIC T1 ~ T6 Gc Zone 20 dust Ex iaD 20 T65/T95/T125 °C Zone 21 dust Ex iaD 21 T65/T95/T125 °C Zone 21 mounting to zone 20 dust Ex iaD 20/21 T65/T95/T125 °C - Ex n Zone 2 gas Ex nA IIC T1 ~ T6 Gc	China
	KCs (option) Hazardous areas - Ex i Zone 0 gas Ex ia IIC T4 ... T6 Zone 1 gas Ex ib IIC T4 ... T6	Korea
-	PESO (option) Hazardous areas - Ex i Zone 0 gas Ex ia IIC T1 ... T6 Ga Zone 1 mounting to zone 0 gas Ex ia IIC T1 ... T6 Ga/Gb Zone 1 gas Ex ia IIC T1 ... T6 Gb	India

1) Only for built-in transmitter

2) Only with connection head, model BSZ, BSZ-H, 1/4000, 5/6000 or 7/8000 (see "Connection housing")

3) Only with connection head, model 1/4000, 5/6000 or 7/8000 (see "Connection housing")

4) Without transmitter

Manufacturer's information and certificates

Logo	Description
	SIL 2 Functional safety (only in conjunction with model T32 temperature transmitter)

Instruments marked with "ia" may also be used in areas only requiring instruments marked with "ib" or "ic".

If an instrument with "ia" marking has been used in an area with requirements in accordance with "ib" or "ic", it can no longer be operated in areas with requirements in accordance with "ia" afterwards.

Approvals and certificates, see website

Sensor

Measuring element

Pt100, Pt1000 ¹⁾ (measuring current: 0.1 ... 1.0 mA) ²⁾

Connection method	
Single element	1 x 2-wire 1 x 3-wire 1 x 4-wire
Dual elements	2 x 2-wire 2 x 3-wire 2 x 4-wire ³⁾

Validity limits of the class accuracy in accordance with EN 60751		
Class	Sensor construction	
	Wire-wound	Thin-film
Class B	-196 ... +450 °C	-50 ... +500 °C
Class A ⁴⁾	-100 ... +450 °C	-30 ... +300 °C
Class AA ⁴⁾	-50 ... +250 °C	0 ... 150 °C

1) Pt1000 only available as a thin-film measuring resistor

2) For detailed specifications for Pt100 sensors, see Technical information IN 00.17 at www.wika.com.

3) Not with 3 mm diameter

4) Not with 2-wire connection method

The table shows the temperature ranges listed in the respective standards, in which the tolerance values (class accuracies) are valid.

The actual working temperature of the thermometer can be limited by the minimum/maximum working temperatures of the single components used.

Different temperature ranges apply for the working temperatures of the components, which are not exposed to the medium but to the environment.

- The combinations of a 2-wire connection with class A or class AA are not permissible, since the lead resistance of the connection lead counteracts the higher sensor accuracy.
- When using a 3-wire connection, we recommend not to exceed a probe length, including the connection cable, of approx. 30 m.
- Longer cable lengths should be designed with a 4-wire connection.

The TR41 can be operated, under certain conditions, in a temperature range outside the temperature range of the specified class. With respect to compliance with the limiting deviation (class accuracy), however, the following must be observed: With standard instruments, the previously specified class can no longer be confirmed if the thermometer was operated above or below the corresponding class temperature range. The dwell time is not relevant here. Even if the temperature is in the range of the selected class again, the class accuracy of the measuring resistor is no longer defined.

Operation outside the measuring range defined for the given class and design can result in permanent damage to the measuring resistor.

Minimum and maximum operating temperature

Process temperature

The process temperature is the temperature which prevails in the area between the probe tip and the process connection.

Short insertion lengths and specific components can limit the operating temperature of the thermometer (e.g. PTFE ferrules on a compression fitting, materials of the connection cables used, components in the probe tip).

Ambient temperature

The area of the transition from probe to connection cable and all subsequent components are located in the region of ambient temperature.

It is important to ensure that the lowest of the maximum permissible ambient temperatures for connection cables, materials used or a fitted connector or case is not exceeded.

- Maximum temperature at connection housing: 80 °C
- Maximum temperature at connector: 80 °C
- Maximum temperature of vibration-resistant versions: 200 °C
- In an optional approval minimum and maximum temperature specified

Other variants on request

With this model, the connection cable extends to the sensor in the probe tip. For this reason, the operating temperatures of the selected connection cable also define the process-side operating temperatures of the instrument.

For information on the maximum permissible operating temperatures for the connection cable see page 13.

The limits of the permissible ambient temperature are, with special low-temperature versions, extended in the lower temperature range to -50 °C. The maximum temperature of these instrument versions is +120 °C.

The use of thermometers with low temperatures in explosion-protected areas is only available with selected approvals.

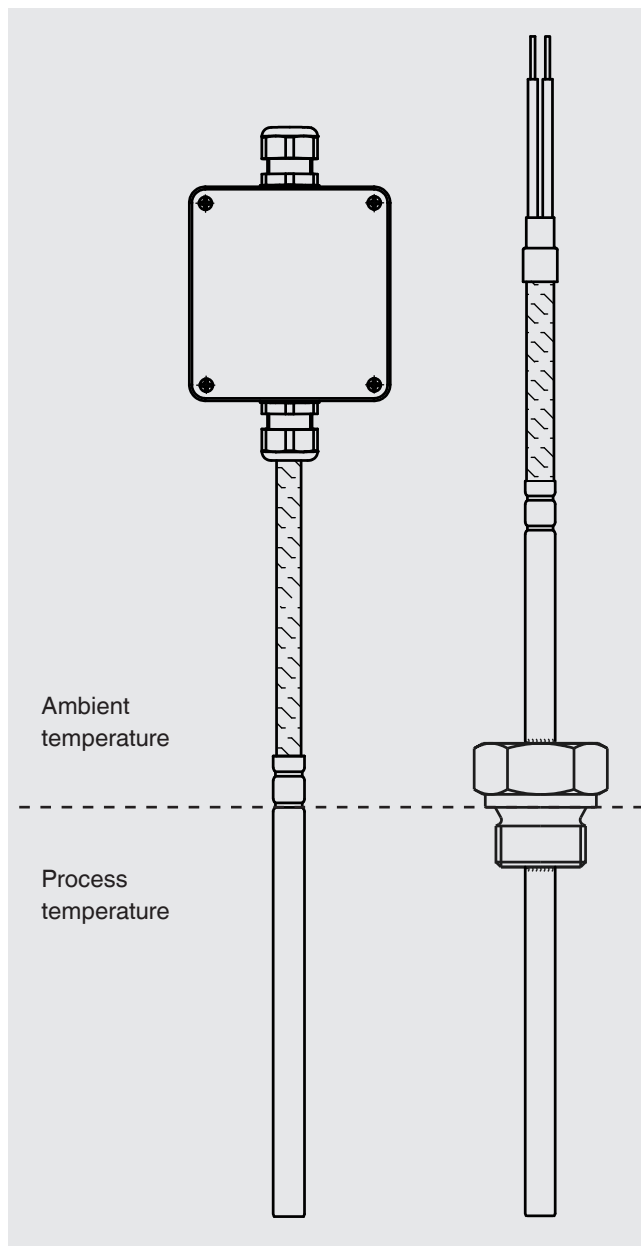

Design of the TR41

Tubular resistance thermometers consist of a stainless steel tube into which the sensor directly connected to the connection cable is inserted up to the probe tip.

For temperature measurement in a solid body, the diameter of the bore into which the probe should be inserted, should be no more than 1 mm larger than the probe diameter. Each air gap acts as an insulation layer.

When installing the TR41 in blind bores in a solid body, the use of a spring-loaded compression fitting is recommended as the process connection.

A uniform contact pressure of the probe on the bottom of the bore ensures an optimal heat transfer. Any thermal expansion forces that occur are absorbed by the spring loading of the compression fitting.

The use of fixed threads or standard compression fittings can damage the probe when used in blind bores.

Versions

■ With connection cable

Standard version

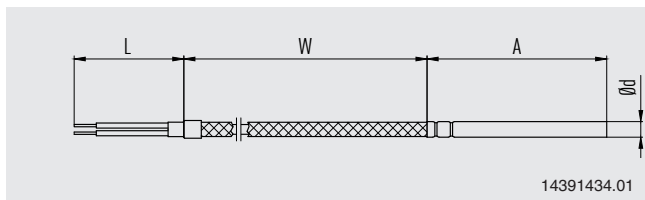

Single wires

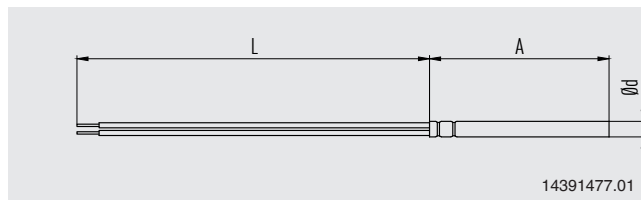

Connection cable with stainless steel braid

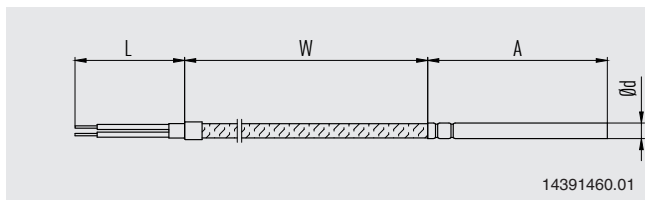

■ With connector

Fitted to the probe end

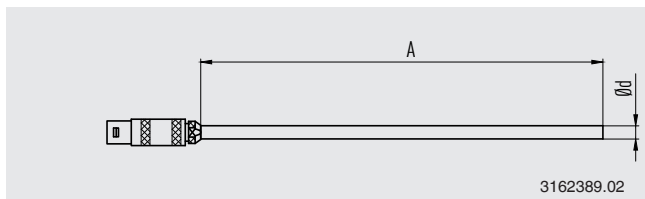

Fitted to the cable end

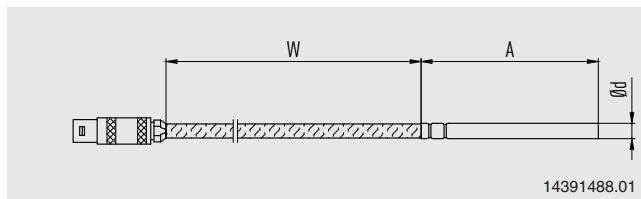

For all ignition protection types except Ex i, gas applies:
Position of the connector is only permitted outside the hazardous area.

■ With connection housing fitted at the cable end

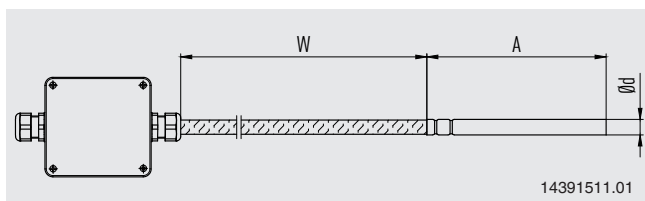

Angled probes

TR41 cable resistance thermometers can be delivered in a pre-formed shape. In this case, the position of the bend is defined by a further dimension.

Using a fixed threaded connection is not recommended, as the angled probe would need to be screwed into the process with a wide sweeping movement.

Legend:

- X Distance of the bend to the end of the tube
- A Insertion length of the probe (section which is built into the process)
- Y Distance from the centre of the bend to the measurement plane of the threaded connection (only if a threaded connection is used)

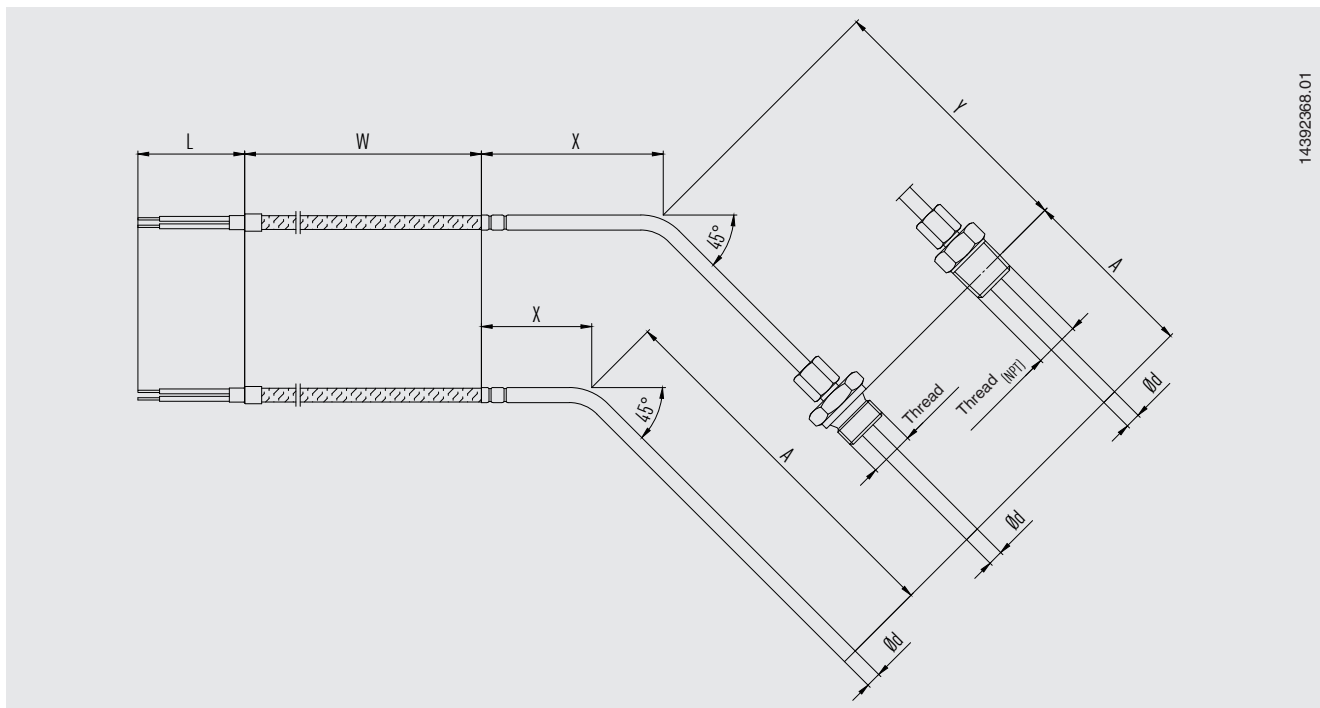
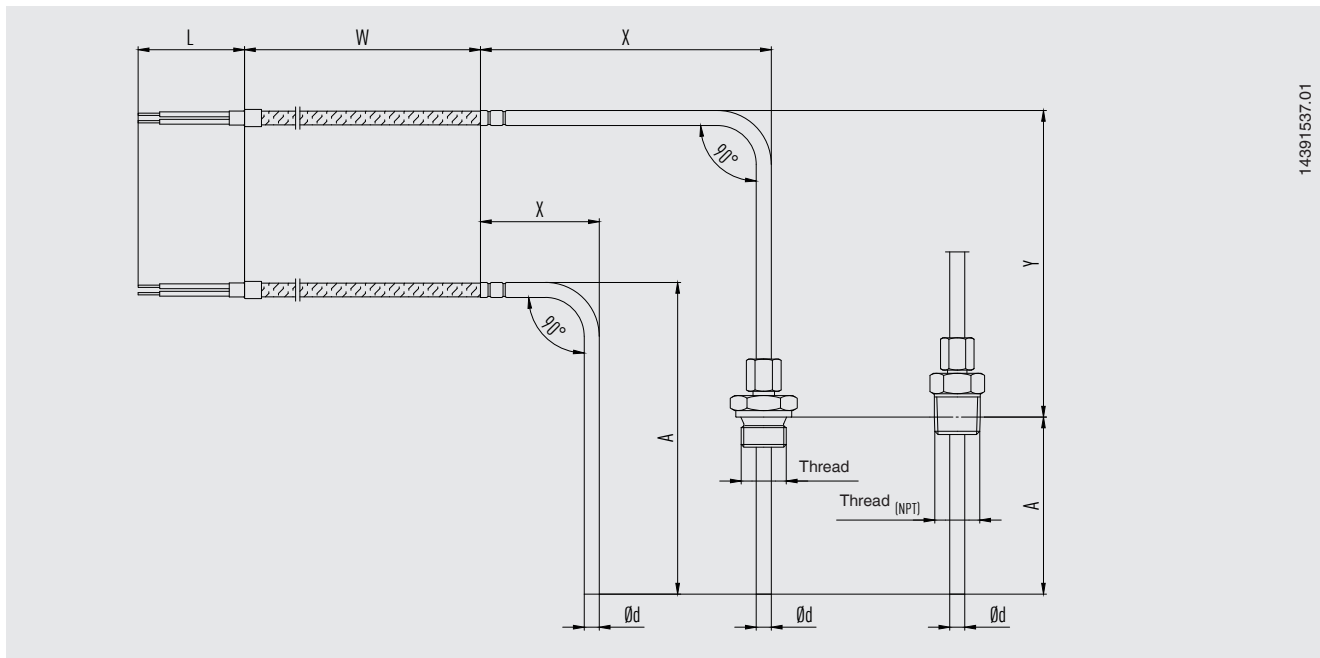

Process connection

TR41 cable resistance thermometers can be fitted with an optional process connection. Compression fittings are loosely enclosed upon delivery.

To minimise heat dissipation errors via the threaded connection, the insertion length, A, should be at least 25 mm long.

Please note:

- For parallel threads (e.g. G 1/2) the dimensioning always refers to the sealing collar of the threaded connection nearest the process
- For tapered threads (e.g. NPT) the measurement plane is located approx. in the centre of the thread

Legend:

- X Position of the threaded connection (independent of the type of connection)
- A Insertion length in the process

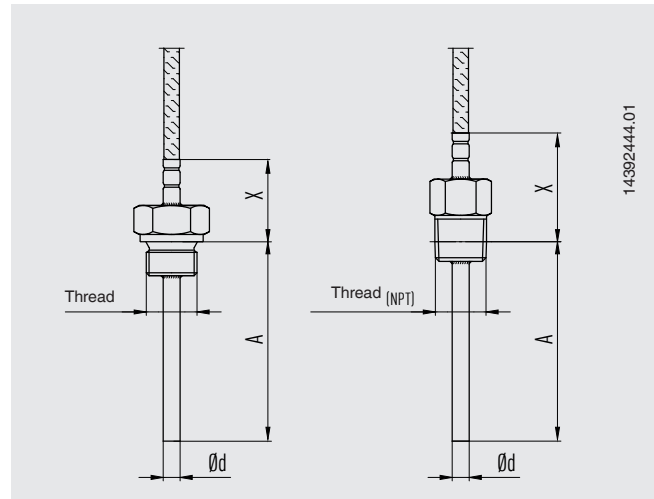

International designs

■ Without process connection

Smooth probe for insertion

Design	Illustration	Material process connection	Thread size	Diameter probe tube	Material probe tube
Without process connection		-	-	<ul style="list-style-type: none"> ■ 3 mm ■ 6 mm ■ 8 mm ■ 1/8 in/0.125 in [3.17 mm] ■ 1/4 in/0.250 in [6.35 mm] ■ 3/8 in/0.375 in [9.53 mm] 	<ul style="list-style-type: none"> ■ Stainless steel 1.4571 ■ Stainless steel 316L

■ Fixed fitting (welded), thread

- Version to mount the probe into a threaded coupling with a female thread
- Probe must be rotated in order to screw it into the process
- Therefore, first fit the version mechanically and then connect it electrically

Design	Illustration	Material process connection	Thread size	Diameter probe tube	Material probe tube
Fixed fitting (welded), thread		<ul style="list-style-type: none"> ■ Stainless steel 1.4571 ■ Stainless steel 316L 	<ul style="list-style-type: none"> ■ G 1/8 B ■ 1/8 NPT ■ M8 x 1.0 	<ul style="list-style-type: none"> ■ 3 mm ■ 1/8 in/0.125 in [3.17 mm] 	<ul style="list-style-type: none"> ■ Stainless steel 1.4571 ■ Stainless steel 316L
			<ul style="list-style-type: none"> ■ G 1/4 B ■ G 3/8 B ■ 1/4 NPT ■ 3/8 NPT ■ M10 x 1.0 	<ul style="list-style-type: none"> ■ 3 mm ■ 6 mm ■ 1/8 in/0.125 in [3.17 mm] ■ 1/4 in/0.250 in [6.35 mm] 	<ul style="list-style-type: none"> ■ Stainless steel 1.4571 ■ Stainless steel 316L
			<ul style="list-style-type: none"> ■ G 1/2 B ■ G 3/4 B ■ 1/2 NPT ■ 3/4 NPT ■ M12 x 1.5 ■ M14 x 1.5 ■ M16 x 1.5 ■ M18 x 1.5 ■ M20 x 1.5 	<ul style="list-style-type: none"> ■ 3 mm ■ 6 mm ■ 8 mm ■ 1/8 in/0.125 in [3.17 mm] ■ 1/4 in/0.250 in [6.35 mm] ■ 3/8 in/0.375 in [9.53 mm] 	<ul style="list-style-type: none"> ■ Stainless steel 1.4571 ■ Stainless steel 316L

■ Compression fitting with stainless steel ferrule

- Simple adjustment at the mounting point to the desired insertion length
- Compression fitting can be slid along the probe (only for the first tightening)
- After loosening, sliding along the probe tube is no longer possible.
- Smallest possible length X of approx. 50 mm (due to the length of the compression fitting)
- Max. temperature at the process connection: 500 °C (unpressurised)
- Max. pressure loading: 20 bar (at max. 150 °C, Ø 6 mm)

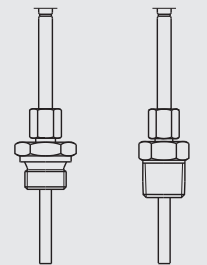
Design	Illustration	Material process connection	Thread size	Diameter probe tube	Material probe tube
Compression fitting with stainless steel ferrule		<ul style="list-style-type: none"> ■ Stainless steel 1.4571 ■ Stainless steel 316L 	<ul style="list-style-type: none"> ■ G 1/8 B ■ 1/8 NPT ■ M8 x 1.0 	<ul style="list-style-type: none"> ■ 3 mm ■ 1/8 in/0.125 in [3.17 mm] 	<ul style="list-style-type: none"> ■ Stainless steel 1.4571 ■ Stainless steel 316L
			<ul style="list-style-type: none"> ■ G 1/4 B ■ G 3/8 B ■ 1/4 NPT ■ 3/8 NPT ■ M10 x 1.0 	<ul style="list-style-type: none"> ■ 3 mm ■ 6 mm ■ 1/8 in/0.125 in [3.17 mm] ■ 1/4 in/0.250 in [6.35 mm] 	<ul style="list-style-type: none"> ■ Stainless steel 1.4571 ■ Stainless steel 316L
			<ul style="list-style-type: none"> ■ G 1/2 B ■ G 3/4 B ■ 1/2 NPT ■ 3/4 NPT ■ M12 x 1.5 ■ M14 x 1.5 ■ M16 x 1.5 ■ M18 x 1.5 ■ M20 x 1.5 	<ul style="list-style-type: none"> ■ 3 mm ■ 6 mm ■ 8 mm ■ 1/8 in/0.125 in [3.17 mm] ■ 1/4 in/0.250 in [6.35 mm] ■ 3/8 in/0.375 in [9.53 mm] 	<ul style="list-style-type: none"> ■ Stainless steel 1.4571 ■ Stainless steel 316L

■ Compression fitting with PTFE ferrule

- Basic construction as for the version with stainless steel ferrule
- Ferrules can be set several times
- After loosening, sliding along the probe tube is possible again.
- Max. temperature at process connection: 150 °C
- For use without pressure

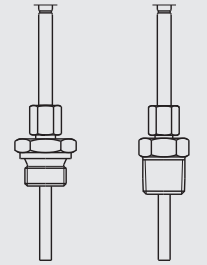
Design	Illustration	Material process connection	Thread size	Diameter probe tube	Material probe tube
Compression fitting with PTFE ferrule		<ul style="list-style-type: none"> ■ Stainless steel 1.4571 ■ Stainless steel 316L 	<ul style="list-style-type: none"> ■ G 1/8 B ■ 1/8 NPT ■ M8 x 1.0 	<ul style="list-style-type: none"> ■ 3 mm ■ 1/8 in/0.125 in [3.17 mm] 	<ul style="list-style-type: none"> ■ Stainless steel 1.4571 ■ Stainless steel 316L
			<ul style="list-style-type: none"> ■ G 1/4 B ■ G 3/8 B ■ 1/4 NPT ■ 3/8 NPT ■ M10 x 1.0 	<ul style="list-style-type: none"> ■ 3 mm ■ 6 mm ■ 1/8 in/0.125 in [3.17 mm] ■ 1/4 in/0.250 in [6.35 mm] 	<ul style="list-style-type: none"> ■ Stainless steel 1.4571 ■ Stainless steel 316L
			<ul style="list-style-type: none"> ■ G 1/2 B ■ G 3/4 B ■ 1/2 NPT ■ 3/4 NPT ■ M12 x 1.5 ■ M14 x 1.5 ■ M16 x 1.5 ■ M18 x 1.5 ■ M20 x 1.5 	<ul style="list-style-type: none"> ■ 3 mm ■ 6 mm ■ 8 mm ■ 1/8 in/0.125 in [3.17 mm] ■ 1/4 in/0.250 in [6.35 mm] ■ 3/8 in/0.375 in [9.53 mm] 	<ul style="list-style-type: none"> ■ Stainless steel 1.4571 ■ Stainless steel 316L

■ **Spring-loaded compression fitting with stainless steel ferrule**

- Easy adjustment to the desired insertion length at the mounting point, while at the same time maintaining the spring pre-tension
- Compression fitting can be slid along the probe (only for the first tightening)
- After loosening, sliding along the probe tube is no longer possible.
- Smallest possible length X of approx. 100 mm (due to the length of the compression fitting)
- Max. temperature at process connection: 150 °C
- For use without pressure
- Hydraulic-oil tight versions on request

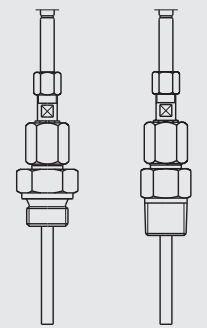
Design	Illustration	Material process connection	Thread size	Diameter probe tube	Material probe tube
Spring-loaded compression fitting with stainless steel ferrule		<ul style="list-style-type: none"> ■ Stainless steel 1.4571 ■ Stainless steel 316L 	<ul style="list-style-type: none"> ■ G 1/4 B ■ G 3/8 B ■ G 1/2 B ■ G 3/4 B ■ 1/4 NPT ■ 3/8 NPT ■ 1/2 NPT ■ 3/4 NPT ■ M10 x 1.0 ■ M12 x 1.5 ■ M14 x 1.5 ■ M16 x 1.5 ■ M18 x 1.5 ■ M20 x 1.5 	6 mm	<ul style="list-style-type: none"> ■ Stainless steel 1.4571 ■ Stainless steel 316L

US design

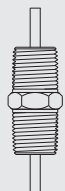
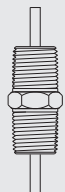
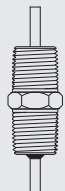
Design	Illustration	Material process connection	Thread size	Diameter probe tube	Material probe tube
Spring-loaded threaded connection (standard)		Stainless steel 316L	<ul style="list-style-type: none"> ■ 1/4 NPT ■ 3/8 NPT ■ 1/2 NPT ■ 3/4 NPT 	<ul style="list-style-type: none"> ■ 6 mm ■ 1/4 in/0.250 in [6.35 mm] ■ 1/8 in/0.125 in [3.17 mm] 	Stainless steel 316L
Spring-loaded threaded connection with O-ring sealing (rated to 100 psi at 86 °C, hydrostatic testing in H ₂ O)		Stainless steel 316L	<ul style="list-style-type: none"> ■ 1/4 NPT ■ 3/8 NPT ■ 1/2 NPT ■ 3/4 NPT 	1/4 in/0.250 in [6.35 mm]	Stainless steel 316L
Fixed fitting/double threaded hex bushing (welded)		Stainless steel 316L	<ul style="list-style-type: none"> ■ 1/2 NPT ■ 3/4 NPT 	1/4 in/0.250 in [6.35 mm]	Stainless steel 316L

Transition

For probe version $d = 3 \text{ mm}$ a transition is necessary!

The junction between the metal part of the probe and the connection lead or stranded wire should not be immersed within the process and must not be bent. Compression fittings should not be attached to the transition sleeve.

The dimensions of the transition sleeve are dependent upon the probe diameter, on the construction of the connection cable and its number of inner conductors - depending on the connection method. Also, operation with ambient temperatures $< -40 \text{ }^\circ\text{C}$ has an influence on the dimensions of the transition sleeve.

Bend protection

A bend protection (spring or shrink hose) is used to protect the transition point from rigid probe to flexible connection lead. This should always be used when a relative movement between the connection lead and the thermometer mounting is expected.

For designs to Ex n or Ex e, the use of bend protection is mandatory.



Bend protection spring



Shrink hose

Both versions should be considered to be technically equivalent with respect to their function as bend protection.

Connection cable, jacket

Cable jacket	Application range ¹⁾
PTFE	-60 ... +250 °C
PTFE, shielded (see standard versions below)	-60 ... +250 °C
Single wires, PTFE	-60 ... +250 °C
Stainless steel braid over PTFE	-60 ... +250 °C
Silicone	-50 ... +180 °C
Silicone, shielded (see standard versions below)	-50 ... +180 °C
PVC	-20 ... +100 °C
Fibreglass	-50 ... +400 °C
Stainless steel braid over fibreglass	-50 ... +400 °C

Minimum/maximum temperatures valid for stationary cable. The actual operating temperature (process temperature) of the thermometer can deviate.

Standard cable lengths

Metric lengths

- 1,000 mm
- 2,000 mm
- 3,000 mm
- 5,000 mm

Imperial lengths

- 24 in
- 36 in
- 72 in
- 144 in

Other cable lengths are possible

Standard versions of the shield electrical connection

- Shield not connected at the sensor, stripped lead at the end of the cable
- Shield connected at the sensor, stripped lead at the end of the cable

- Shield not connected at the sensor, connected at the case
- Shield connected at the sensor, connected at the case

- Shield not connected at the sensor, connected at the connector
- Shield connected at the sensor, connected at the connector
- Shield connected at the sensor, not connected at the connector

Other versions on request

Design of the lead ends

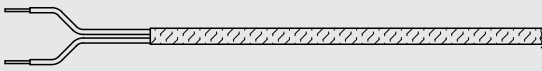
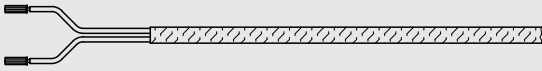
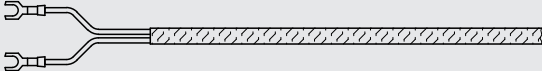
Version	Illustration
Flying leads ¹⁾	
End splices	
Spade lugs (fork design)	

Cord grip

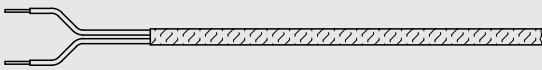
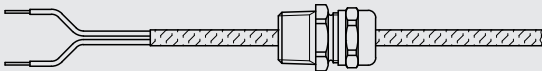
Thread size	Material	Illustration
Without	-	
M16 x 1.5	Plastic	
M20 x 1.5	Plastic	
1/2 NPT	Plastic	
1/2 NPT	Metal	
3/4 NPT	Metal	

1) Not permissible with Ex e or Ex n

Connection housing (option)

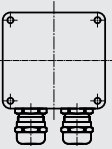
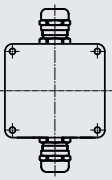

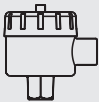
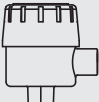
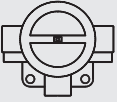
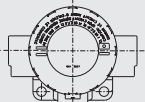
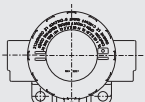

Illustration	Model	Material	Cable entry thread size	Cover	Surface	Other
	Field case	Plastic (ABS)	<ul style="list-style-type: none"> ■ M12 x 1.5 ■ 1/2 NPT ■ M16 x 1.5 	Flat cover with 4 plug screws	Grey	<ul style="list-style-type: none"> ■ 82 x 80 x 55 mm (L x W x H) ■ Inputs on one side
	Field case	Aluminium	<ul style="list-style-type: none"> ■ M12 x 1.5 ■ 1/2 NPT ■ M16 x 1.5 	Flat cover with 4 plug screws	Blank	<ul style="list-style-type: none"> ■ 80 x 75 x 57 mm (L x W x H) ■ Inputs on one side
	Field case	Plastic (ABS)	<ul style="list-style-type: none"> ■ M12 x 1.5 ■ 1/2 NPT ■ M16 x 1.5 	Flat cover with 4 plug screws	Grey	<ul style="list-style-type: none"> ■ 82 x 80 x 55 mm (L x W x H) ■ Inputs opposite each other
	Field case	Aluminium	<ul style="list-style-type: none"> ■ M12 x 1.5 ■ 1/2 NPT ■ M16 x 1.5 	Flat cover with 4 plug screws	Blank	<ul style="list-style-type: none"> ■ 80 x 75 x 57 mm (L x W x H) ■ Inputs opposite each other
	1/4000	Aluminium	<ul style="list-style-type: none"> ■ M20 x 1.5 ■ 1/2 NPT ■ 3/4 NPT 	Screw-on lid	Blue, painted ¹⁾	-
	1/4000	Stainless steel	<ul style="list-style-type: none"> ■ M20 x 1.5 ■ 1/2 NPT ■ 3/4 NPT 	Screw-on lid	Blank	-

Illustration	Model	Material	Cable entry thread size	Cover	Surface	Other
	7/8000	Aluminium	<ul style="list-style-type: none"> ■ M20 x 1.5 ■ 1/2 NPT ■ 3/4 NPT 	Screw-on lid	Blue, painted ¹⁾	-
	7/8000	Stainless steel	<ul style="list-style-type: none"> ■ M20 x 1.5 ■ 1/2 NPT ■ 3/4 NPT 	Screw-on lid	Blank	-
	7/8000	Aluminium	<ul style="list-style-type: none"> ■ M20 x 1.5 ■ 1/2 NPT ■ 3/4 NPT 	Screw-on lid, with digital temperature display DIH50-B	Blue, painted ¹⁾	-
	7/8000	Stainless steel	<ul style="list-style-type: none"> ■ M20 x 1.5 ■ 1/2 NPT ■ 3/4 NPT 	Screw-on lid, with digital temperature display DIH50-B	Blank	-
	5/6000	Aluminium	<ul style="list-style-type: none"> ■ 2 x M20 x 1.5 ■ 2 x 1/2 NPT ■ 2 x 3/4 NPT 	Screw-on lid	Blue, painted ¹⁾	-
	5/6000	Stainless steel	<ul style="list-style-type: none"> ■ 2 x M20 x 1.5 ■ 2 x 1/2 NPT ■ 2 x 3/4 NPT 	Screw-on lid	Blank	-
	5/6000	Aluminium	<ul style="list-style-type: none"> ■ 2 x M20 x 1.5 ■ 2 x 1/2 NPT ■ 2 x 3/4 NPT 	Screw-on lid, with digital temperature display DIH50-B	Blue, painted ¹⁾	-
	5/6000	Stainless steel	<ul style="list-style-type: none"> ■ 2 x M20 x 1.5 ■ 2 x 1/2 NPT ■ 2 x 3/4 NPT 	Screw-on lid, with digital temperature display DIH50-B	Blank	-
	Field transmitter TIF50 ²⁾	Aluminium	<ul style="list-style-type: none"> ■ 2 x M20 x 1.5 ■ 2 x 1/2 NPT ■ 2 x 3/4 NPT 	-	-	-
	Field transmitter TIF50 ²⁾	Stainless steel	<ul style="list-style-type: none"> ■ 2 x M20 x 1.5 ■ 2 x 1/2 NPT ■ 2 x 3/4 NPT 	-	-	-
	Field transmitter TIF52 ²⁾	Aluminium	<ul style="list-style-type: none"> ■ 2 x M20 x 1.5 ■ 2 x 1/2 NPT ■ 2 x 3/4 NPT 	-	-	-
	Field transmitter TIF52 ²⁾	Stainless steel	<ul style="list-style-type: none"> ■ 2 x M20 x 1.5 ■ 2 x 1/2 NPT ■ 2 x 3/4 NPT 	-	-	-
	KN4-A ²⁾	Aluminium	<ul style="list-style-type: none"> ■ M20 x 1.5 ■ 1/2 NPT ■ 3/4 NPT 	Screw-on lid	Blue, painted ¹⁾	-
	KN4-P ²⁾	Polypropylene	<ul style="list-style-type: none"> ■ M20 x 1.5 ■ 1/2 NPT ■ 3/4 NPT 	Screw-on lid	White	-
	BSZ ³⁾	Aluminium	<ul style="list-style-type: none"> ■ M20 x 1.5 ■ 1/2 NPT 	Spherical, hinged cover with plug screw	Blue, painted ¹⁾	-
	BSZ-H ³⁾	Aluminium	<ul style="list-style-type: none"> ■ M20 x 1.5 ■ 1/2 NPT 	High hinged cover with plug screw	Blue, painted ¹⁾	-

1) RAL 5022

2) Not permissible with Ex e or Ex n

3) Not permissible with IECEx (Ex e or Ex n) and NEPSI (Ex n)

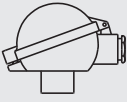
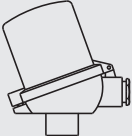
Model	Explosion protection					
	Without	Ex i (gas) Zone 0, 1, 2	Ex i (dust) Zone 20, 21, 22	Ex e (gas) Zone 1, 2	Ex t (dust) Zone 21, 22	Ex nA (gas) Zone 2
Field case, plastic (ABS)	x	-	-	-	-	-
Field case, aluminium	x	x	x	x	x	x
1/4000	x	x	x	x	x	x
7/8000	x	x	x	x	x	x
7/8000 / DIH50 ²⁾	x	x	x	-	-	-
5/6000	x	x	x	x	x	x
TIF50	x	x	x	-	-	-
TIF52	x	x	x	-	-	-
KN4-A	x	x	-	-	-	-
KN4-P ¹⁾	x	-	-	-	-	-
BSZ	x	x	x	x ³⁾	x ³⁾	x ³⁾
BSZ-H	x	x	x	x ³⁾	x ³⁾	x ³⁾

1) On request

2) LC display DIH50

3) Only ATEX, no IECEx, no NEPSI

Position of the probe input

The standard probe input is located at position C.
 Another position for the probe input is possible as an option.

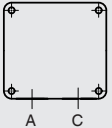
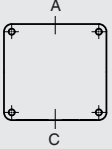
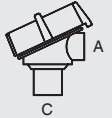
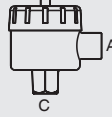
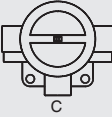
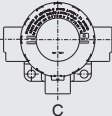
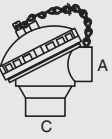
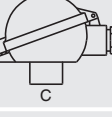
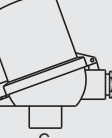
Illustration	Connection housing
	Field case with inputs on either side
	Field case with inputs on either side
	Connection housing 1/4000
	Connection housing 7/8000 Connection housing 7/8000 with DIH50
	Connection housing 5/6000
	Connection housing 5/6000 with DIH50-B Field transmitter TIF50/TIF52
	Connection head KN4-A
	Connection head BSZ
	Connection head BSZ-H

Cable entry

Cable entry	Colour	Ingress protection (max.) IEC/EN 60529 ¹⁾	Cable entry thread size	Min./max. ambient temperature
 Standard cable entry ²⁾	Blank	IP65	■ M20 x 1.5 ■ ½ NPT	-40 ... +80 °C
 Plastic cable gland (cable Ø 6 ... 10 mm) ²⁾	Black or grey	IP66 ³⁾	■ M20 x 1.5 ■ ½ NPT	-40 ... +80 °C
 Plastic cable gland (cable Ø 6 ... 10 mm), Ex e ²⁾	Light blue or black	IP66 ³⁾	■ M20 x 1.5 ■ ½ NPT	■ -20 ... +80 °C ■ -40 ... +70 °C
 Nickel-plated brass cable gland (cable Ø 6 ... 12 mm)	Blank	IP66 ³⁾	■ M20 x 1.5 ■ ½ NPT	-60 ⁴⁾ / -40 ... +80 °C
 Nickel-plated brass cable gland (cable Ø 6 ... 12 mm), Ex e	Blank	IP66 ³⁾	■ M20 x 1.5 ■ ½ NPT	-60 ⁴⁾ / -40 ... +80 °C
 Stainless steel cable gland (cable Ø 7 ... 12 mm)	Blank	IP66 ³⁾	■ M20 x 1.5 ■ ½ NPT	-60 ⁴⁾ / -40 ... +80 °C
 Stainless steel cable gland (cable Ø 7 ... 12 mm), Ex e	Blank	IP66 ³⁾	■ M20 x 1.5 ■ ½ NPT	-60 ⁴⁾ / -40 ... +80 °C
 Plain threaded	-	IP00	■ M20 x 1.5 ■ ½ NPT	-
 2 x plain threaded ⁵⁾	-	IP00	■ 2 x M20 x 1.5 ■ 2 x ½ NPT	-
 Junction box M12 x 1 (4-pin) ⁶⁾	-	IP65	M20 x 1.5	-40 ... +80 °C
 Sealing plugs for shipping	Transparent	-	■ M20 x 1.5 ■ ½ NPT	-40 ... +80 °C

The figures show examples of connection heads.

1) IP ingress protection of the cable gland. The IP ingress protections of the complete instrument TR41 must not inevitably correspond to the cable gland.

2) Not available for BVS connection head

3) Ingress protections, describing temporary or permanent immersion, on request

4) Special version on request (only available with selected approvals), other temperatures on request

5) Only for BSZ-H connection head

6) Not available for ½ NPT thread size cable entry

Cable entry	Explosion protection					
	Without	Ex i (gas) Zone 0, 1, 2	Ex i (dust) Zone 20, 21, 22	Ex e (gas) Zone 1, 2	Ex t (dust) Zone 21, 22	Ex nA (gas) Zone 2
Standard cable entry ¹⁾	x	x	-	-	-	-
Plastic cable gland ¹⁾	x	x	-	-	-	-
Plastic cable gland (light blue), Ex e ¹⁾	x	x	x	-	-	-
Plastic cable gland (black), Ex e ¹⁾	x	x	x	x	x	x
Brass cable gland, nickel-plated	x	x	x	-	-	-
Brass cable gland, nickel-plated, Ex e	x	x	x	x	x	x
Stainless steel cable gland	x	x	x	-	-	-
Stainless steel cable gland, Ex e	x	x	x	x	x	x
Plain threaded	x	x	x ⁵⁾	x ⁵⁾	x ⁵⁾	x ⁵⁾
2 x plain threaded ²⁾	x	x	x ⁵⁾	x ⁵⁾	x ⁵⁾	x ⁵⁾
Junction box M12 x 1 (4-pin) ³⁾	x	x ⁴⁾	x ⁴⁾	-	-	-
Sealing plugs for shipping	Not applicable, transport protection					

1) Not available for BVS connection head

2) Only for BSZ-H connection head

3) Not available for ½ NPT thread size cable entry

4) With appropriate mating connector connected

5) Suitable cable gland required for operation

Transmitter built into the connection housing (option)

A transmitter can be mounted in an optional connection housing.

HART
COMMUNICATION PROTOCOL



Output signal 4 ... 20 mA, HART® protocol		
Transmitter (selectable versions)	Model T15	Model T32
Data sheet	TE 15.01	TE 32.04
Output		
4 ... 20 mA	x	x
HART® protocol	-	x
Connection method		
1 x 2-wire, 3-wire or 4-wire	x	x
Measuring current	< 0.2 mA	< 0.3 mA
Explosion protection	Optional	Optional

For detailed specifications on the explosion protection of the transmitter, see respective transmitter data sheet.

Accessories, connection housing

Pipe mounting kit, stainless steel (for field case)

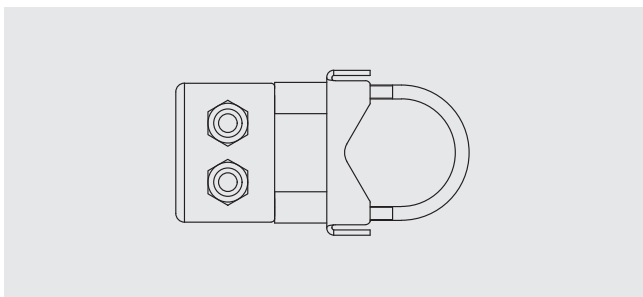

Pipe mounting kit, stainless steel (for 5/6000, DIH50/DIH52, TIF50/TIF52)

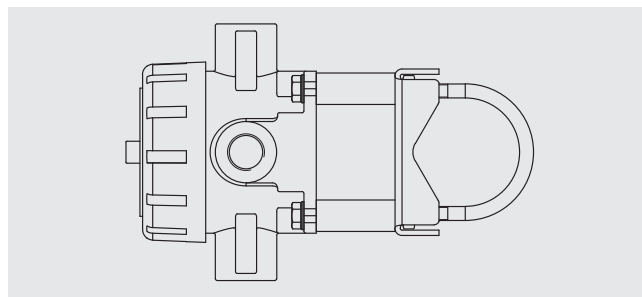

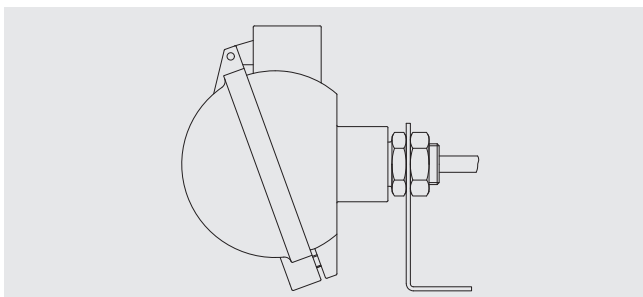

Fixing bracket (for wall mounting) 92 x 60 x 50 mm, stainless steel (for connection head models BSZ and BSZ-H)

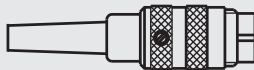
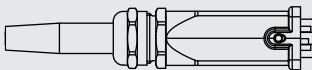
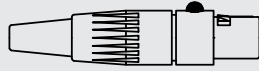
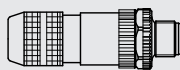

Connector (option)

Cable resistance thermometers can be supplied with connectors fitted.
The following options are available:

Illustration	Model
	Lemos connector (male)
	Binder/Amphenol screw/plug-in connector (male)
	Harting connector (male)
	XLR-mini connector (female)
	Binder screw/plug-in connector, M12 x 1 (male)
	Thermo connector (male)

The figures are not to scale.

Ingress protection per IEC/EN 60529

Ingress protections against solid foreign bodies (defined by the 1st index number)

First index number	Ingress protection / Short description	Test parameters
4	Protected against solid foreign bodies of 1.0 mm diameter and larger	per IEC/EN 60529
5	Dust-protected	per IEC/EN 60529
6	Dust-tight	per IEC/EN 60529

Ingress protections against water (defined by the 2nd index number)

Second index number	Ingress protection / Short description	Test parameters
0	Not protected	-
4	Protected against splash water	per IEC/EN 60529
5	Protected against water jets	per IEC/EN 60529

All data for the second index number are based on water as the test medium (IEC/EN 60529).
Use of the instruments in other media will invalidate the guarantee/warranty.

Model TR41 is available in the following IP ingress protections:

- IP40
- IP50
- IP54 (standard)
- IP65

The specified ingress protections apply under the following conditions:

- Use of a suitable cable gland
- Use of a cable cross-section appropriate for the gland or select the appropriate cable gland for the available cable
- Adhere to the tightening torques for all threaded connections

Classification of the IP ingress protection zones for the probes

- Version with connection cable

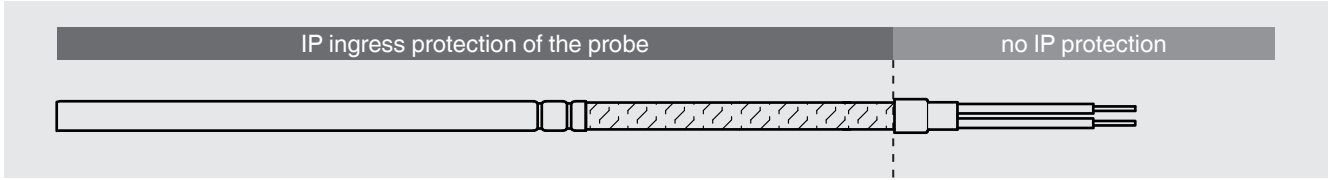

- Version with connection housing, fitted at the cable end

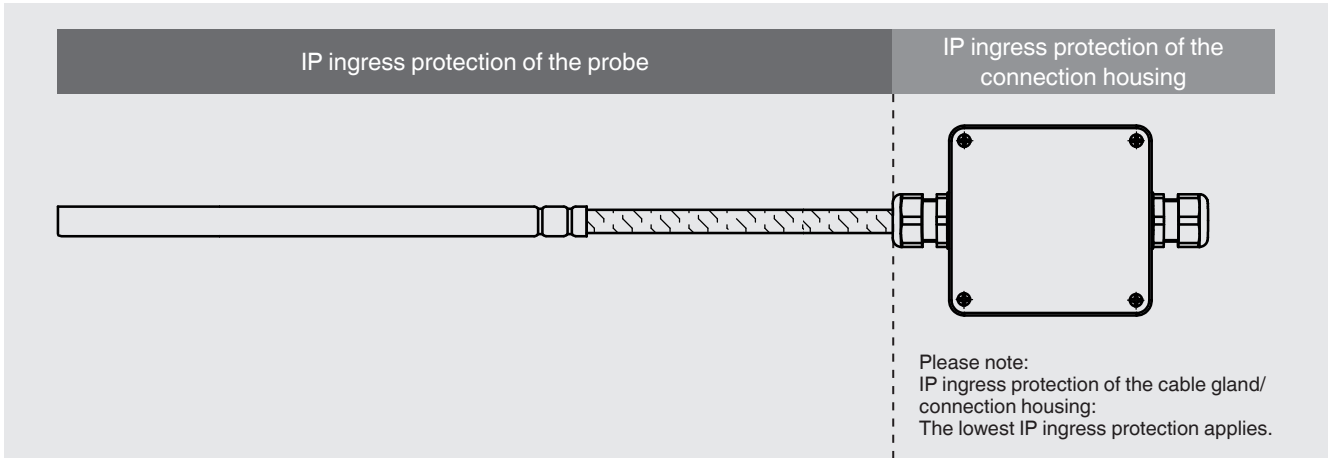

- Version with connector, fitted at the cable end

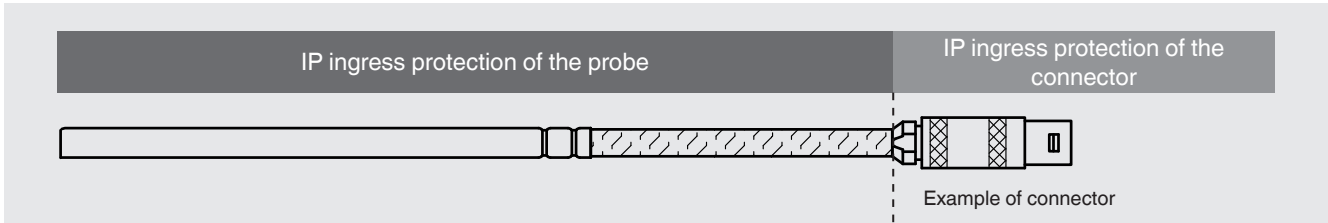

- Version with connector, fitted at the probe tube

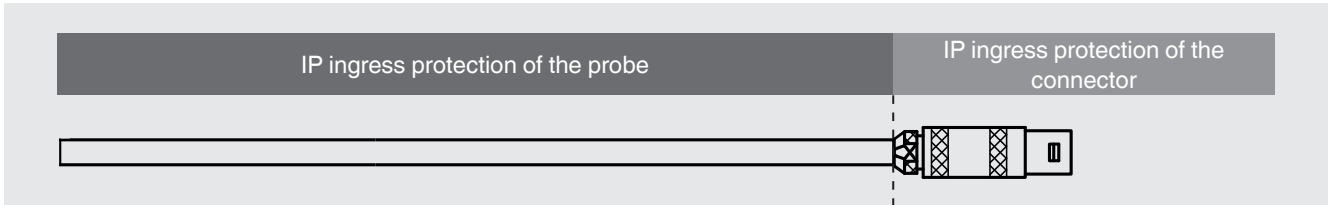

IP ingress protection of the connection housings

Connection housing	Version	IP ingress protection
Field case	Plastic (ABS) / aluminium	IP65
Connection head	KN4-A	IP65
	KN4-P	
	BSZ	
	BSZ-H	
	1/4000	IP66
	5/6000	
	5/6000 with DIH50	
	7/8000	
7/8000 with DIH50		
Field transmitter	TIF50/TIF52	IP66

Note:

Even if the selected connection housing would allow a higher IP ingress protection, the maximum ingress protection of the instrument is IP65.

IP ingress protection of the connector

Connector	Version	IP ingress protection
Binder	Series 680	IP40
	Series 692	
	Series 423	
Amphenol	C16-3	IP40
Lemos	Size 0 S	IP50
	Size 1 S	
	Size 2 S	
	Size 1 E	IP65
Harting	7D	IP65
	8D	
	8U	
XLR	3-pin/4-pin, miniature	IP65
M12 x 1	4-pin	IP65
Thermo connector	2-pin, standard/miniature	IP00
	3-pin, standard/miniature	

Electrical connection

Without connector

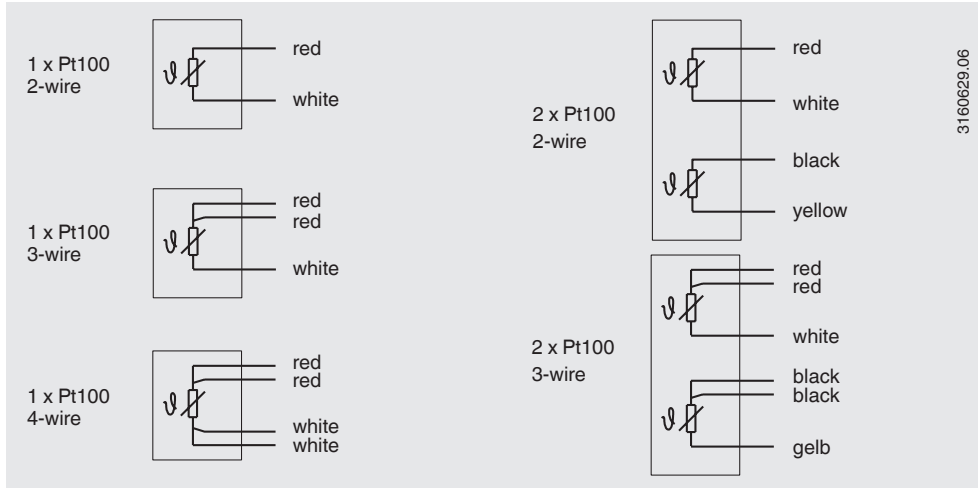

Lemosa connector

max. permissible temperature range see page 5

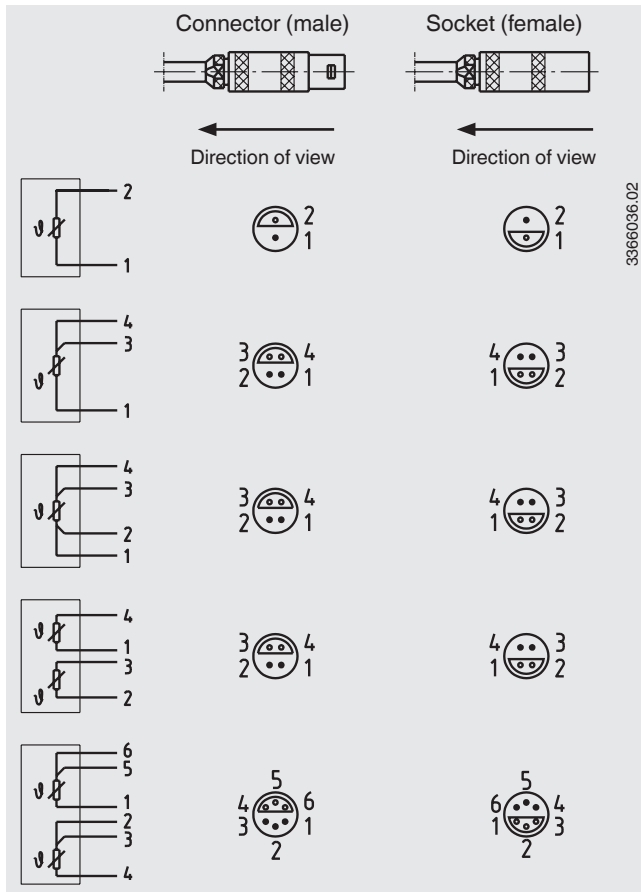

Screw/plug-in connector (Amphenol, Binder)

max. permissible temperature range see page 5

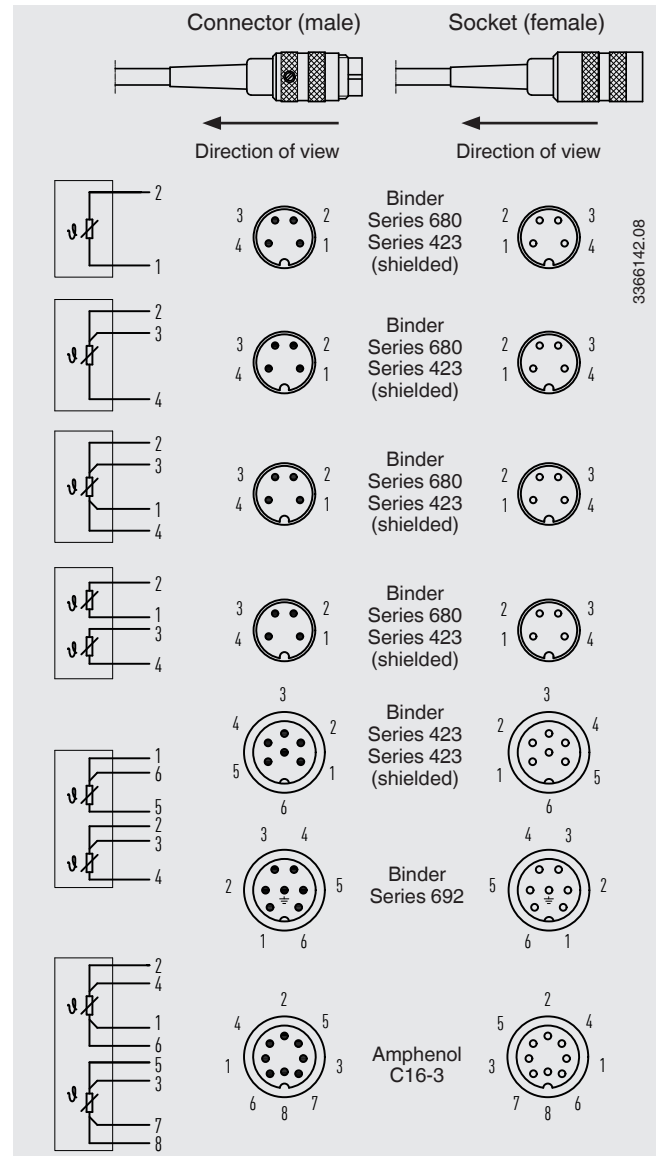

Thermo connector (RTD, male)

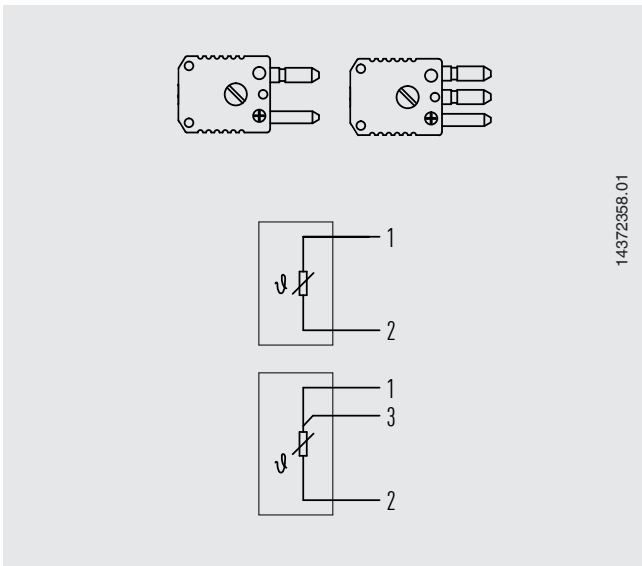

XLR-mini connector (female)

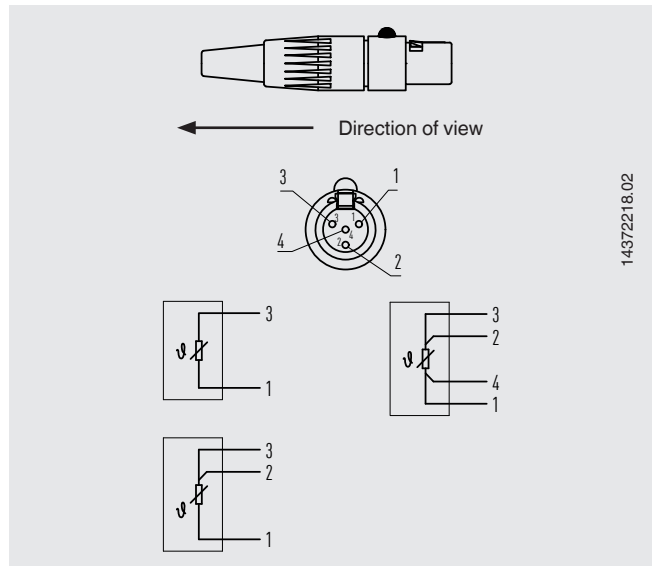

Binder screw/plug-in connector (male), M12 x 1 (series 713)

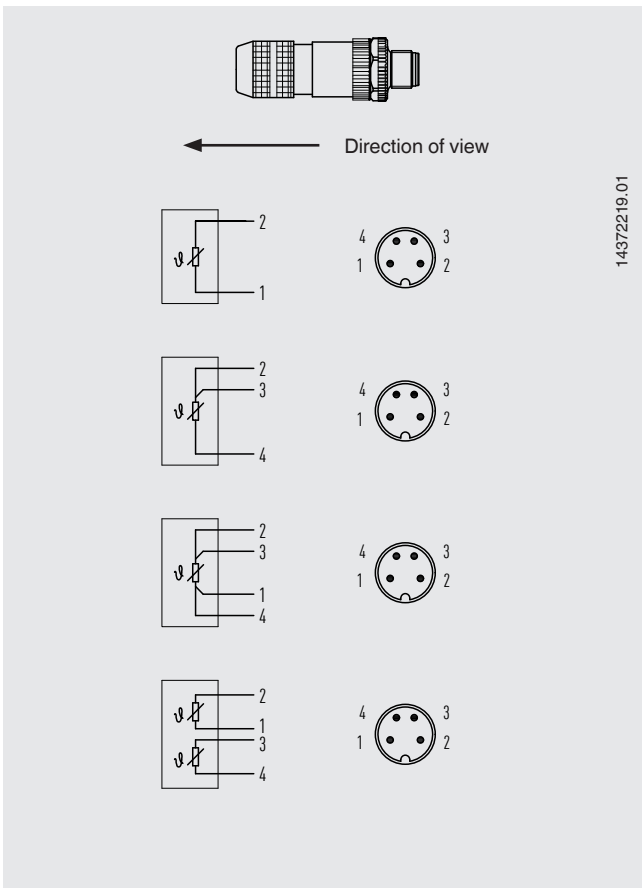

Harting connector

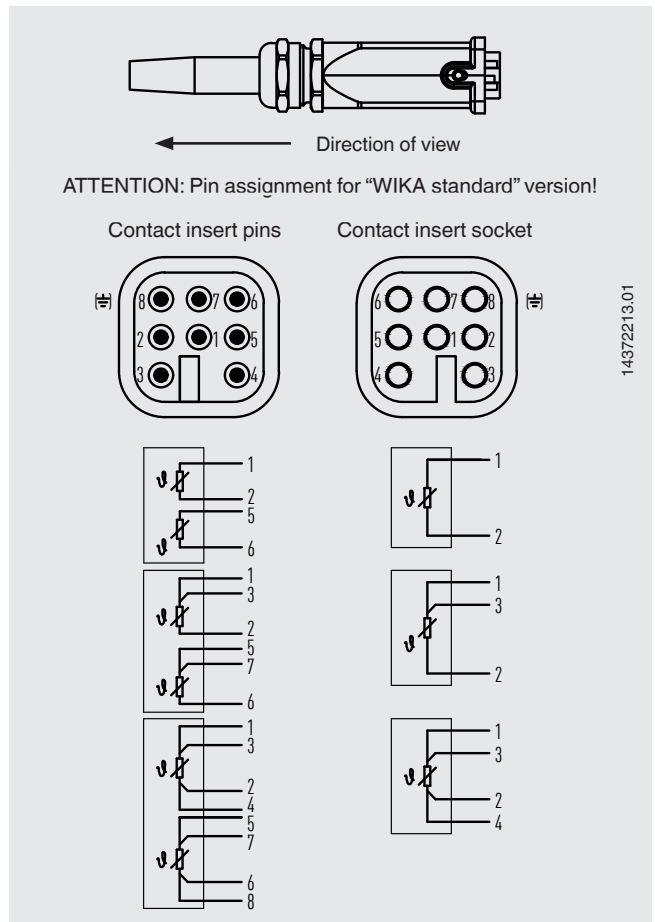

Standard terminal block (colour code in accordance with IEC/EN 60751)

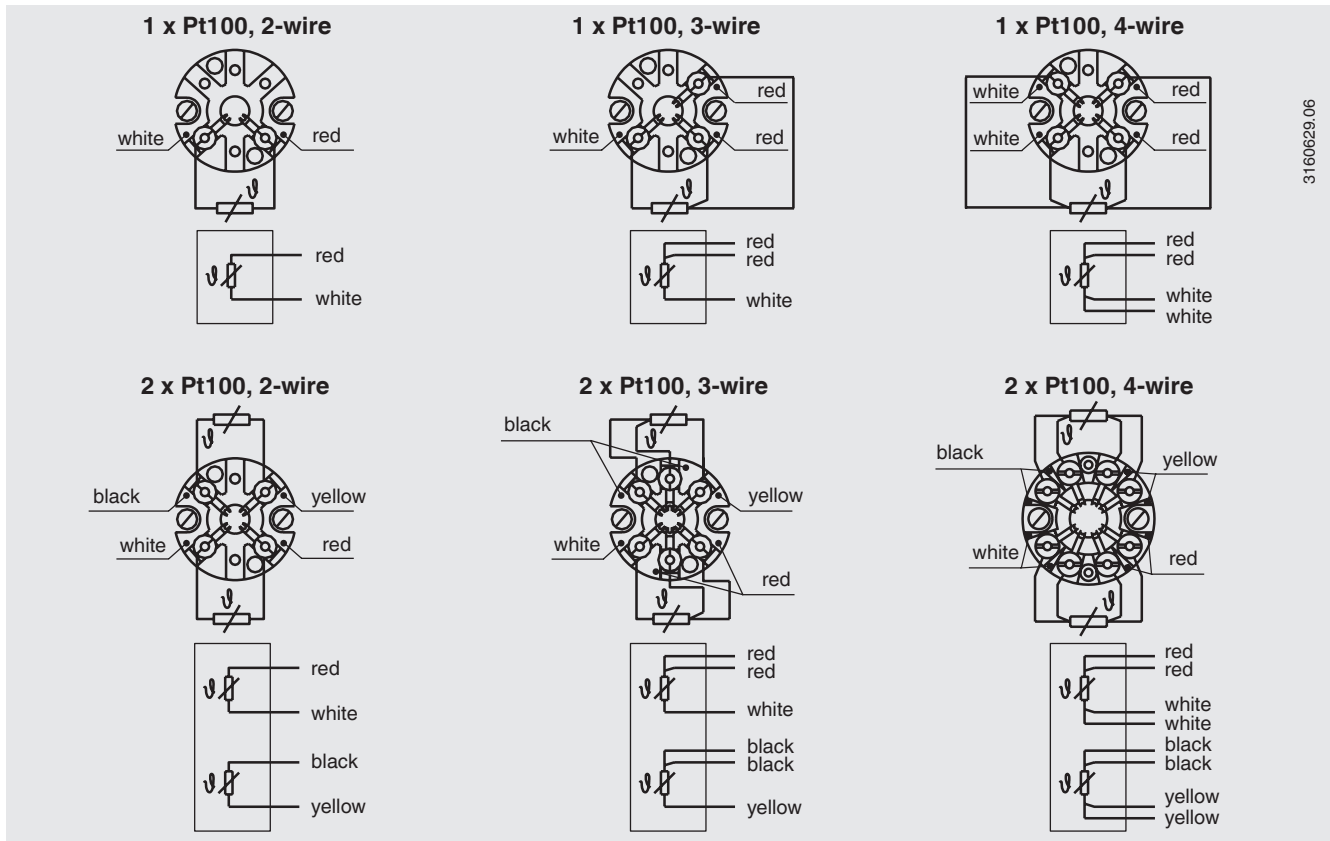

Assignment and colour coding for Pt1000 as for Pt100
Pt1000 only available as single elements

Rack-mounting terminals

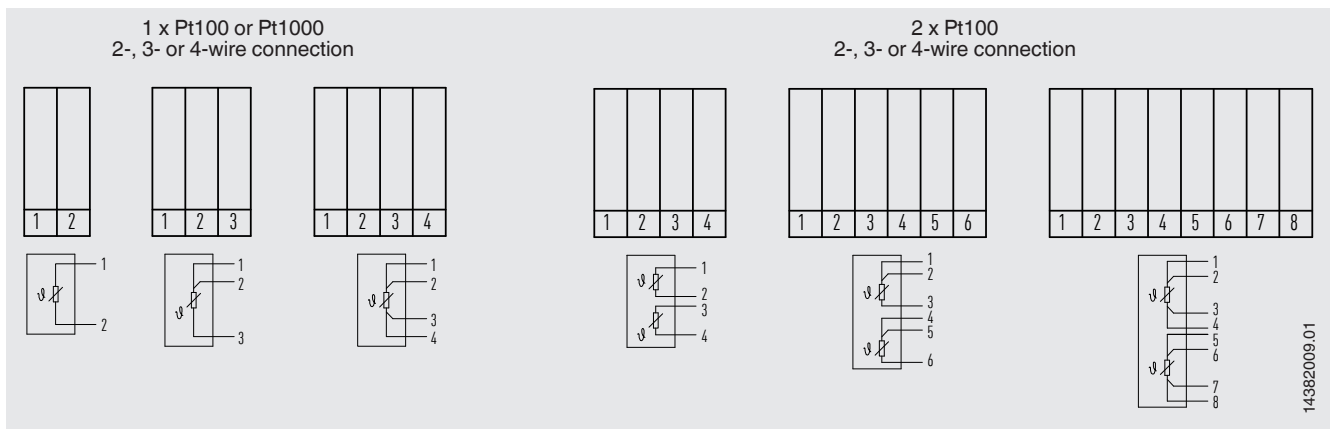

Operating conditions

Mechanical requirements

6 g peak-to-peak, 10 ... 500 Hz, wire-wound or thin film measuring resistor

The information on vibration resistance refers to the tip of the probe.

For detailed specifications on the vibration resistance of Pt100 sensors, see Technical information IN 00.17 at www.wika.com.

Storage temperature

-40 ... +80 °C

Other storage temperatures on request

Certificates (option)

Certification type	Measurement accuracy	Material certificate
2.2 test report	x	x
3.1 inspection certificate	x	x
DAkkS calibration certificate	x	-

The different certifications can be combined with each other.

The minimum length (metal part of the probe or the length of the probe below the process connection) for carrying out a measurement accuracy test 3.1 or DAkkS is 100 mm [3.94 in].

Calibration of shorter lengths on request.

Ordering information

Model / Explosion protection / Probe version / Threaded connection version / Thread size / Materials / Probe diameter / Measuring element / Connection method / Temperature range / Connection cable, jacket / Lead ends version / Certificates / Options

© 05/2021 WIKA Alexander Wiegand SE & Co. KG, all rights reserved.
The specifications given in this document represent the state of engineering at the time of publishing.
We reserve the right to make modifications to the specifications and materials.

