

Operating Instructions

Indicating and adjustment module for IPT-1* sensors



Contents

1	About this document	
1.1	Function	3
1.2	Target group	3
1.3	Symbolism used	3
2	For your safety	
2.1	Authorised personnel	4
2.2	Appropriate use	4
2.3	Warning about misuse	4
2.4	General safety instructions	4
2.5	Safety approval markings and safety tips	4
2.6	CE conformity	4
2.7	Compatibility according to NAMUR NE 53	5
2.8	Safety instructions for Ex areas	5
3	Product description	
3.1	Configuration	6
3.2	Principle of operation	7
3.3	Operation	7
3.4	Packaging, transport and storage	8
4	Mounting	
4.1	Mounting steps	9
5	Set up	
5.1	Adjustment system	11
5.2	General functions	12
5.3	Special functions - 4 ... 20 mA/HART	18
5.4	Special functions - Profibus PA	20
5.5	Menu schematic	23
5.6	Menu schematic	26
5.7	Menu schematic	28
6	Maintenance and fault rectification	
6.1	Maintenance	30
6.2	Instrument repair	30
7	Dismounting	
7.1	Dismounting steps	31
7.2	Disposal	31
8	Supplement	
8.1	Technical data	32
8.2	Dimensions	33

1 About this document

1.1 Function

This operating instructions manual provides all the information you need for mounting, connection and setup as well as important instructions for maintenance and fault rectification. Please read this information before putting the instrument into operation and keep this manual accessible in the immediate vicinity of the device.

1.2 Target group

This operating instructions manual is directed to trained qualified personnel. The contents of this manual should be made available to these personnel and put into practice by them.

1.3 Symbolism used



Information, tip, note

This symbol indicates helpful additional information.



Caution: If this warning is ignored, faults or malfunctions can result.

Warning: If this warning is ignored, injury to persons and/or serious damage to the instrument can result.

Danger: If this warning is ignored, serious injury to persons and/or destruction of the instrument can result.



Ex applications

This symbol indicates special instructions for Ex applications.



List

The dot set in front indicates a list with no implied sequence.



Action

This arrow indicates a single action.



Sequence

Numbers set in front indicate successive steps in a procedure.

2 For your safety

2.1 Authorised personnel

All operations described in this operating instructions manual must be carried out only by trained specialist personnel authorised by the plant operator.

During work on and with the device the required personal protective equipment must always be worn.

2.2 Appropriate use

The pluggable indicating and adjustment module is used for remote measured value indication and parameter adjustment for IPT-1* pressure transmitters.

2.3 Warning about misuse

Inappropriate or incorrect use of the instrument can give rise to application-specific hazards, e.g. vessel overfill or damage to system components through incorrect mounting or adjustment.

2.4 General safety instructions

This is a high-tech instrument requiring the strict observance of standard regulations and guidelines. The user must take note of the safety instructions in this operating instructions manual, the country-specific installation standards as well as all prevailing safety regulations and accident prevention rules.

The instrument must only be operated in a technically flawless and reliable condition. The operator is responsible for trouble-free operation of the instrument.

During the entire duration of use, the user is obliged to determine the compliance of the required occupational safety measures with the current valid rules and regulations and also take note of new regulations.

2.5 Safety approval markings and safety tips

The safety approval markings and safety tips on the device must be observed.

2.6 CE conformity

This device fulfills the legal requirements of the applicable EC guidelines. By attaching the CE mark, we provide confirmation of successful testing.

2.7 Compatibility according to NAMUR NE 53

With respect to compatibility, NAMUR recommendation NE 53 is met.

The parameter adjustment of the basic sensor functions is independent of the software version. The range of available functions depends on the respective software version of the individual components.

2.8 Safety instructions for Ex areas

Please note the Ex-specific safety information for installation and operation in Ex areas. These safety instructions are part of the operating instructions manual and come with the Ex-approved instruments.

3 Product description

3.1 Configuration

Scope of delivery

The scope of delivery encompasses:

- Indicating and adjustment module
- Documentation
 - this operating instructions manual

Equipment

The indicating and adjustment module is equipped with a display with full-dot matrix as well as four keys for adjustment. An integrated backlight can be switched via the adjustment menu. The following hardware versions are necessary:

- Indicating and adjustment module ...- 01 or higher
- Sensor electronics 4 ... 20 mA ...- 02 or higher
- Sensor electronics Profibus PA or Foundation Fieldbus ...- 03 or higher
-

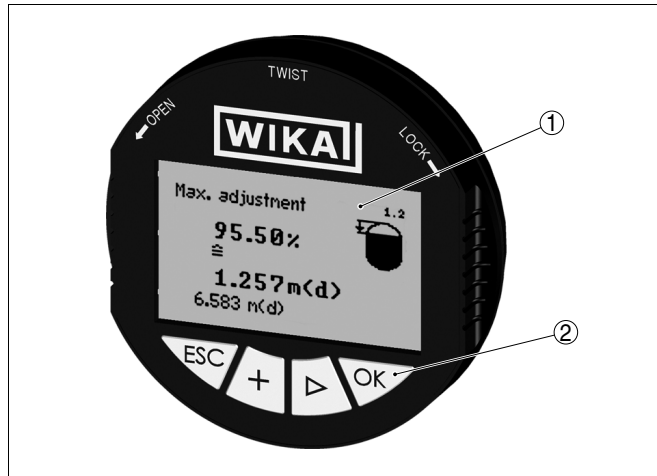

Fig. 1: Indicating and adjustment module

- 1 Display
- 2 Keys

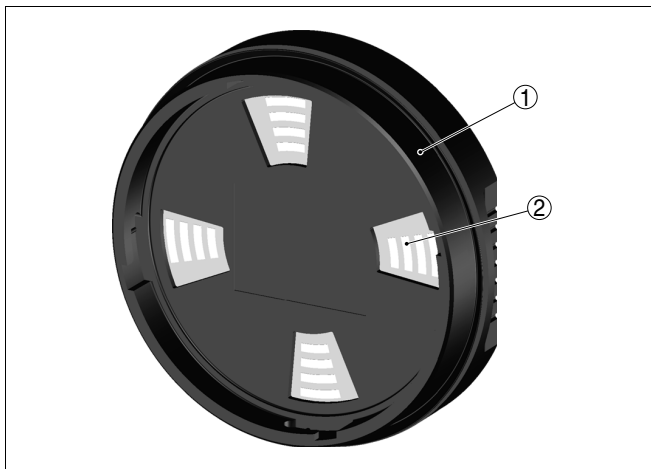

Fig. 2: Rear of the indicating/adjustment module

- 1 Integrated seal ring
- 2 Gold plated contact paths

3.2 Principle of operation

Application area

The indicating and adjustment module is used for measured value indication, adjustment, and diagnostics for the following WIKAI® sensors:

- IPT-10 vers. 2.0 (ceramic sensor)
- IPT-1* vers. 3.0 (metallic sensor)
- IPT-11 vers. 4.0 (ceramic sensor)

The indicating and adjustment module is mounted into the respective sensor housing or into the external housing. After mounting, the sensor and the external housing are also splash water proof without housing cover.

The operation of two indicating and adjustment modules in parallel in the sensor and in the external housing is not supported.

Power supply

Power supply directly via the respective sensor or the external housing. An additional connection is not necessary.

3.3 Operation

The adjustment is carried out via the integrated keys. The entered parameters are generally saved in the respective sensor. A copy function enables loading of the parameters into the indicating and adjustment module.

3.4 Packaging, transport and storage

Packaging

Your instrument was protected by packaging during transport. Its capacity to handle normal loads during transport is assured by a test according to DIN EN 24180.

The packaging of standard instruments consists of environment-friendly, recyclable cardboard. For special versions, PE foam or PE foil is also used. Dispose of the packaging material via specialised recycling companies.

Transport

Transport must be carried out under consideration of the notes on the transport packaging. Nonobservance of these instructions can cause damage to the device.

Transport inspection

The delivery must be checked for completeness and possible transit damage immediately at receipt. Ascertained transit damage or concealed defects must be appropriately dealt with.

Storage

Up to the time of installation, the packages must be left closed and stored according to the orientation and storage markings on the outside.

Unless otherwise indicated, the packages must be stored only under the following conditions:

- Not in the open
- Dry and dust free
- Not exposed to corrosive media
- Protected against solar radiation
- Avoiding mechanical shock and vibration

Storage and transport temperature

- Storage and transport temperature see chapter "*Supplement - Technical data - Ambient conditions*"
- Relative humidity 20 ... 85 %

4 Mounting

4.1 Mounting steps

Mount/Dismount indicating and adjustment module

The indicating and adjustment module can be inserted or removed at any time. It is not necessary to interrupt the voltage supply.

For mounting, proceed as follows:

- 1 Unscrew the housing cover
- 2 Place the indicating/adjustment module in the requested position on the electronics



Information:

Four different positions are possible, each displaced by 90°.

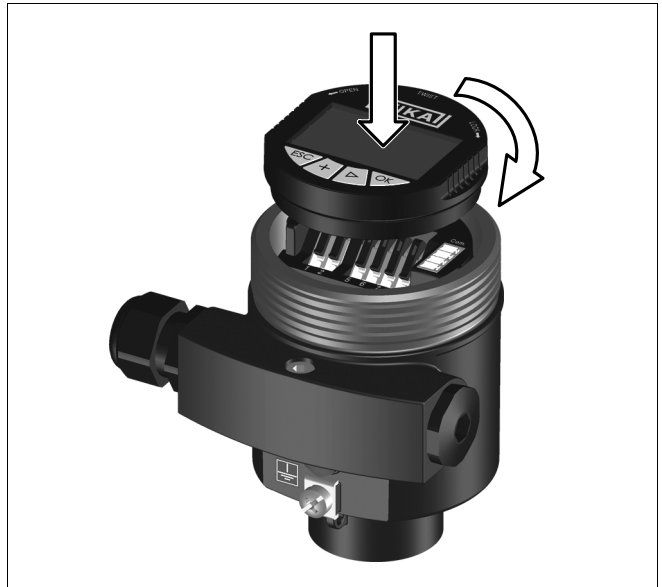

Fig. 3: Mounting the indicating and adjustment module

- 3 Press the indicating/adjustment module lightly onto the electronics and turn it to the right until it snaps in
- 4 Screw housing cover with inspection window tightly back on



Note:

If you intend to retrofit the instrument with an indicating and adjustment module for continuous measured value indication, a higher cover with an inspection glass is required.

Dismounting is carried out in reverse order.

5 Set up

5.1 Adjustment system

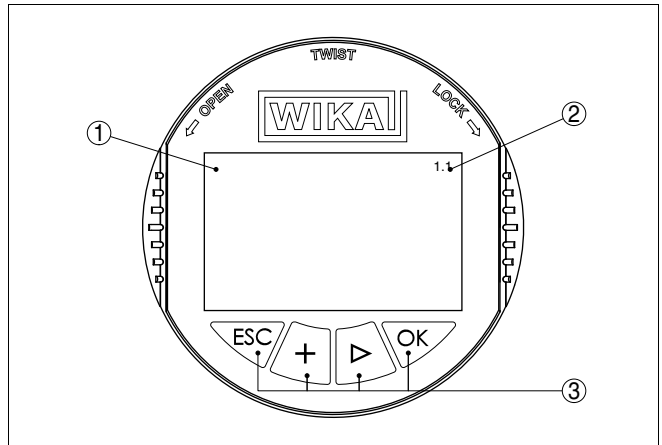

Fig. 4: Indicating and adjustment elements

- 1 LC display
- 2 Indication of the menu item number
- 3 Adjustment keys

Key functions

- **[OK]** key:
 - Move to the menu overview
 - Confirm selected menu
 - Edit parameter
 - Save value
- **[->]** key to select:
 - menu change
 - list entry
 - Select editing position
- **[+]** key:
 - Change value of the parameter
- **[ESC]** key:
 - interrupt input
 - jump to the next higher menu

Adjustment system

The sensor is adjusted via the four keys of the indicating and adjustment module. The LC display indicates the individual menu items. The functions of the individual keys are shown in the above illustration. Approx. 10 minutes after the last pressing of a key, an automatic reset to measured value indication is triggered. Any values not confirmed with **[OK]** will not be saved.

5.2 General functions

Introduction

IPT-1* pressure transmitters have various functions. Hence they can be adapted to the respective application.

Some of these functions are sensor-specific. These are described in the operating instructions manual of the corresponding sensor. Other functions, however, have a general character, i.e. they are available in different sensors.

The general functions are described in this paragraph. The functions of the indicating/adjustment module are determined by the sensor and correspond to the respective software version of the sensor.

Measured value indication

The following presentations are available in the measured value display:

- Level or pressure as digital value, sensor-TAG
- Level or pressure as digital value and bar graph, sensor TAG
- Level or pressure as digital value, temperature value

With [**->**] you select the different presentations of the measured value. You can reach the menu overview from any presentation with [**OK**]. With [**ESC**] you return from the menu overview to the measured value display.

Menu overview

In the menu overview you select the appropriate menu with [**->**] and open it with [**OK**]. Then the individual menu items are available.

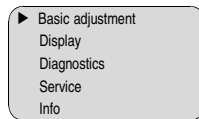

Menu section, basic adjustment

Damping

To damp process-dependent measured value fluctuations, you have to set an integration time of 0 ... 999 s in this menu item.

Depending on the sensor type, the factory setting is 0 s or 1 s.



Linearisation curve

In this menu item you select the linearization curve:

- linear
- Cylindrical tank
- Spherical tank
- User programmable

User programmable means: Switching on a linearization curve programmed via PC and PACTware

The linearization curve creates a correlation between height and volume. It takes into account the vessel geometry for the displayed measured value and current output.

Factory setting is linear.

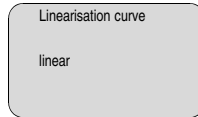

Edit sensor TAG

In the menu item "*Sensor-TAG*" you edit a 12-digit measurement loop name. An unambiguous designation can hence be assigned to the sensor, e.g. the measurement loop name or the tank or product designation. In digital systems and in the documentation of larger plants, a singular designation should be entered for exact identification of individual measuring sites.

The available digits comprise:

- Letters from A ... Z
- Numbers from 0 ... 9
- Special characters +, -, /, -

Factory setting is "*Sensor*".

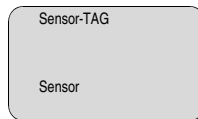

Lighting

Menu section, display

An integrated background lighting can be switched via the adjustment menu. The following version is necessary:

- Indicating and adjustment module ...- 01 or higher
- Sensor electronics 4 ... 20 mA ...- 01 or higher
- Sensor electronics pressure transmitter 4 ... 20 mA ...- 02 or higher
- Sensor electronics Profibus PA or Foundation Fieldbus ...- 03 or higher

The version is stated on the type label of the indicating and adjustment module or the sensor electronics. The function depends also on the height of the supply voltage, see operating instructions manual of the respective sensor.

In the default setting, the lightning is switched off.

Pointer

Min. and max. measured values are saved in the sensor. The values are displayed in the menu item "*Peak values*".

- Min. and max. pressure¹⁾

¹⁾ Pressure: -50 ... +150 % of the nominal measuring range.

- Min. and max. temperature²⁾

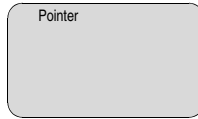

Sensor status

In this menu item, the device status is displayed. If the sensor detects a fault, "OK" will be displayed. If a fault is detected, a flashing failure message is outputted sensor-specifically, e.g. "E013". The fault is also displayed in clear text, e.g. "No measurement value".



Information:

The fault message as well as the clear text indication are also carried out in the measured value display.

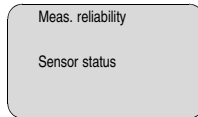

Curve presentation

Available with the trend curve:

- "X-Zoom": Resolution in minutes, hours or days
- "Stop/Start": Interrupt a recording or start a new recording
- "Unzoom": Reset the resolution to minutes

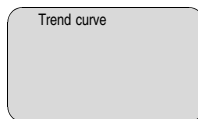

Simulation of measured values

Menu section, service

In this menu item you simulate a user-defined level or pressure value via the current output. This allows you to test the signal path, e.g. through connected indicating instruments or the input card of the control system.

The following simulation variables are available:

- Percent
- Current
- Pressure

With Profibus PA sensors, the selection of the simulated value is made via the "Channel" in the menu "Basic adjustments".

How to start the simulation:

²⁾ Temperature: -50 ... +150 °C.

- 1 Push **[OK]**
- 2 Select the requested simulation variable with **[->]** and confirm with **[OK]**
- 3 Set the requested value with **[+]** and **[->]**.
- 4 Push **[OK]**

The simulation is now running, with 4 ... 20 mA/HART a current is outputted and with Profibus PA or Foundation Fieldbus a digital value.

How to interrupt the simulation:

→ Push **[ESC]**



Information:

The simulation is terminated automatically 10 minutes after the last key has been pushed.

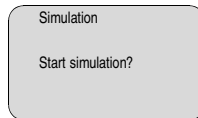

Reset

With the reset function, modified values are reset. Three subfunctions are available:

- Basic adjustment
 - Reset the values modified with the indicating and adjustment module to the basic setting
- Factory setting
 - As basic adjustment, but also reset of special parameters to the delivery status
- Peak values measured value and temperature
 - Reset the min./max. values of pressure and temperature to the current values

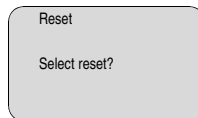

Unit of measurement

For pressure transmitters more comprehensive units are available. They are described in the operating instructions manual of the respective sensor in the menu "*Basic adjustments*".

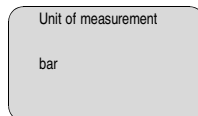

Language

The sensor is already set to the ordered national language. In this menu item you can change the language. The following languages are available, e.g. in software version 3.50:

- Deutsch
- English
- Français
- Españōl
- Pycckuu
- Japanese
- Italiano
- Netherlands
- Japanese
- Chinese

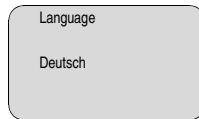

Copy sensor data

With this function

- Load parameter adjustment data from the sensor into the indicating and adjustment module
- Write parameter adjustment data from the indicating and adjustment module into the sensor

The data are permanently saved in an EEPROM memory in the indicating and adjustment module and remain there even in case of power failure. From there, they can be written in one or several sensors or kept as backup for a probable sensor exchange.

Kind and volume of the copied data is stated in the operating instructions manual of the respective sensor.



Information:

Before writing the data into the sensor, it is checked if the data fit the sensor. If data do not fit, a fault signal is triggered or the function is blocked. When writing data into the sensor, you will see from which instrument type the data originate and which TAG-no. this sensor had.

The following items are checked:

- Software version
- WHG approval
- SIL activated
- Measuring principle
- Signal output
- Pressure measuring range



PIN

In this menu item, the PIN is activated/deactivated permanently. Entering a 4-digit PIN protects the sensor data against unauthorized access and unintentional modifications. If the PIN is activated permanently, it can be deactivated temporarily (i.e. for approx. 60 min.) in any menu item. The instrument is delivered with the PIN set to 0000.

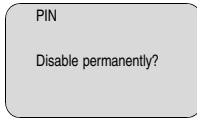

Only the following functions are permitted with activated PIN:

- Select menu items and show data
- Read data from the sensor into the indicating/adjustment module.

Menu section, info

Info

In this menu item the most important sensor information can be displayed:

- Sensor type
- Serial number: 8-digit number, e.g. 12345678

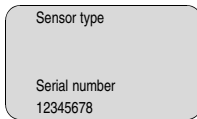

- Date of manufacture: Date of the factory calibration, e.g. 10. January 2008
- Software version: Edition of the sensor software, e.g. 3.50

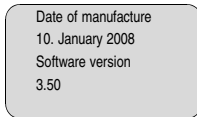

- Date of last change using PC: Date of the last change of sensor parameters via PC, e.g. 10. January 2008

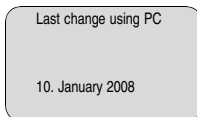

- Sensor details, e.g. approval, process fitting, seal, measuring cell, measuring range, electronics, housing, cable entry, plug, cable length etc.

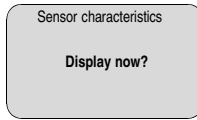

5.3 Special functions - 4 ... 20 mA/HART

Introduction

The 4 ... 20 mA/HART special functions are briefly described in this paragraph. The respective range of functions of the indicating and adjustment module is determined by the sensor and the sensor software version.

Display

In the menu item "*Display*" you can define how the measured value should be presented on the display.

The following indication values are available:

- Height
- Pressure (only with pressure transmitters)
- Current
- Scaled
- Percent
- Lin. percent
- Temperature

The selection "*scaled*" opens the menu items "*Display unit*" and "*Scaling*". In "*Display unit*" there are the following options:

- Height
- Mass
- Flow
- Volume
- Without unit

Depending on selection, the different units are in turn available.

In the menu item "*Scaling*", the requested numerical value with decimal point is entered for 0 % and 100 % of the measured value.

There is the following relation between the indication value in the menu "*Display*" and the adjustment unit in the menu "*Basic adjustment*":

- With pressure, displayed value "*Pressure*" or "*Height*" means: presentation of the measured value in the selected adjustment unit, e.g. bar or m.

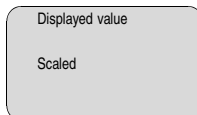

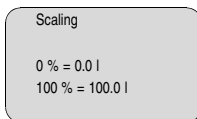
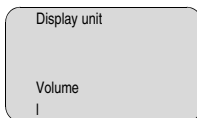

Current output

Menu section, service

In the menu item "*Current output*" you determine the behaviour of the current output during operation and in case of failure. The following options are available:

Current output

Characteristics curve	4 ... 20 mA 20 ... 4 mA
Failure mode ³⁾	Hold value 20.5 mA 22 mA < 3.6 mA
Min. current ⁴⁾	3.8 mA 4 mA
Max. current ⁵⁾	20 mA 20.5 mA

The values in bold font represent the data of the factory setting.

In HART multidrop mode, the current is constantly 4 mA. This value does not change even in case of failure.

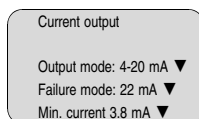

Functional safety (SIL)

The functional safety is already activated Ex factory for instruments with SIL qualification. For instruments Ex factory without SIL qualification, the functional safety must be activated by the user for applications according to SIL via the indicating and adjustment module. The SIL factory setting cannot be deactivated by the user.

The activation of SIL has the following impact:

- 3) Value of the current output in case of failure, e.g. if no valid measured value is delivered.
- 4) This value is not underrun during operation.
- 5) This value is not exceeded during operation.

- In the menu item "*Failure mode*" under "*Current output*", the parameters "*Hold value*" and "*20.5 mA*" are blocked
- In the menu item "*HART mode*", the function "*Multidrop*" is blocked

**Note:**

For such applications, it is absolutely necessary to take note of "*Safety Manual*".

HART mode

HART offers standard and multidrop mode.

The mode standard with the fixed address 0 means output of the measured value as 4 ... 20 mA signal.

In Multidrop mode, up to 15 sensors can be operated on one two-wire cable. An address between 1 and 126 must be assigned to each sensor.⁶⁾

In this menu item you determine the HART mode and enter the address for multidrop.

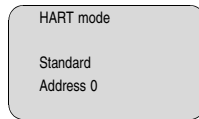

The default setting is standard with address 0.

5.4 Special functions - Profibus PA

Introduction

The Profibus PA special functions are briefly described in this paragraph. The respective range of functions of the indicating and adjustment module is determined by the sensor and the sensor software revision.

Menu section, basic adjustment**Sensor address**

Level and pressure sensors operate as slaves on the Profibus PA. To be identified as a bus participant, each sensor must have a unique address. Each instrument is delivered with address 126. With this address, it can at first be connected to an existing bus. However, the address must be changed. This can be done in this menu item.

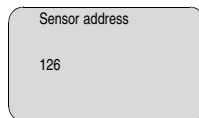

⁶⁾ The 4 ... 20 mA signal of the HART sensor is switched off. The sensor consumes a constant current of 4 mA. The measuring signal is transmitted exclusively as digital HART signal.

Channel

The channel is the input selector switch for function block (FB) of the sensor. Within the function block, additional scalings (Out-Scale) are carried out. In this menu item, the value fir the function block is selected:

- SV1 (Secondary Value 1):
 - Pressure or height
- SV2 (Secondary Value 2):
 - Percent
- PV (Primary Value):
 - Linearised percentage value

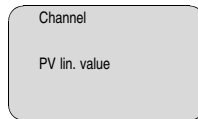

Display

A pressure transmitter delivers the following measured values:

- SV1 (Secondary Value 1): Pressure or height value before adjustment
- SV2 (Secondary Value 2): Percentage value after the adjustment
- PV (Primary Value): Linearised percentage value
- PA-Out (value after passing the function block): PA output
- Temperature

In the menu item "*Display*" you can define which measured value should be presented on the display.

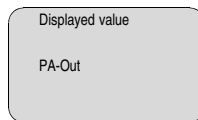

Additional PA value

Profibus transmits two values cyclically. The first value is determined in the menu item "*Channel*". The additional cyclical value is selected in the menu item "*Additional PA value*".

With pressure transmitters the following values are available:

- SV1 (Secondary Value 1): Pressure or height value before adjustment
- SV2 (Secondary Value 2): Percentage value after the adjustment
- PV (Primary Value): Linearised percentage value

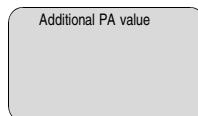

Determine Out-Scale

Here, you determine the unit and scaling for PA-Out. These settings also apply to the values displayed on the indicating and adjustment module if in the menu item "*Displayed value*" PA-Out was selected.⁷⁾

In the menu item "*PV-Out-Scale*", the requested numerical value with decimal point is entered for 0 % and 100 % of the measured value.

Out-Scale-Unit

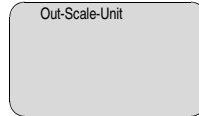

PV-Out-Scale

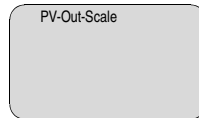

⁷⁾ The following display values are available in "Out-Scale-Unit": Pressure, height, mass, flow, volume, others (without unit, %, mA).

5.5 Menu schematic



Information:

Depending on the version and application, the highlighted menu windows are not always available.

Basic adjustment

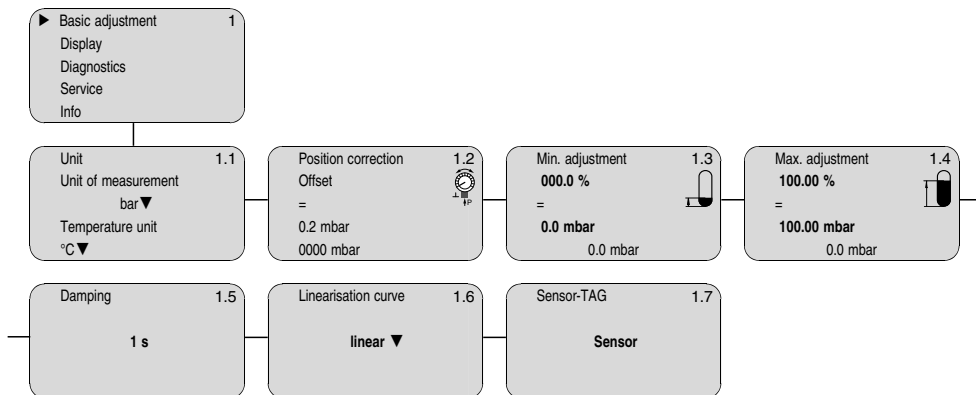

Display

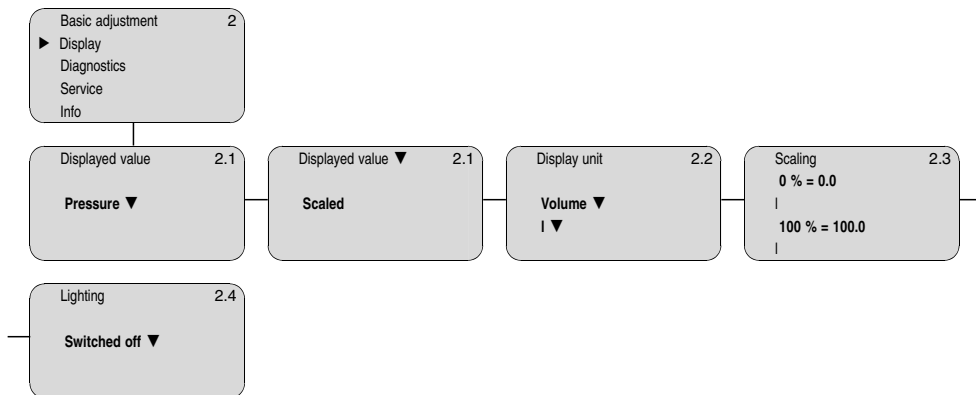

Diagnostics

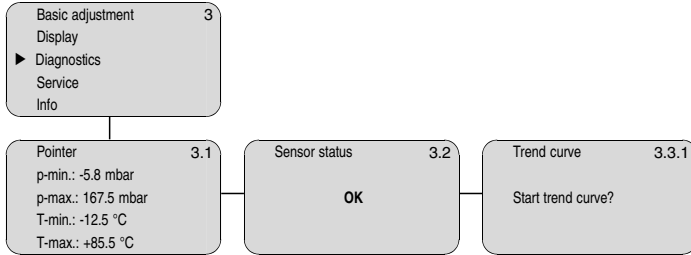

Service

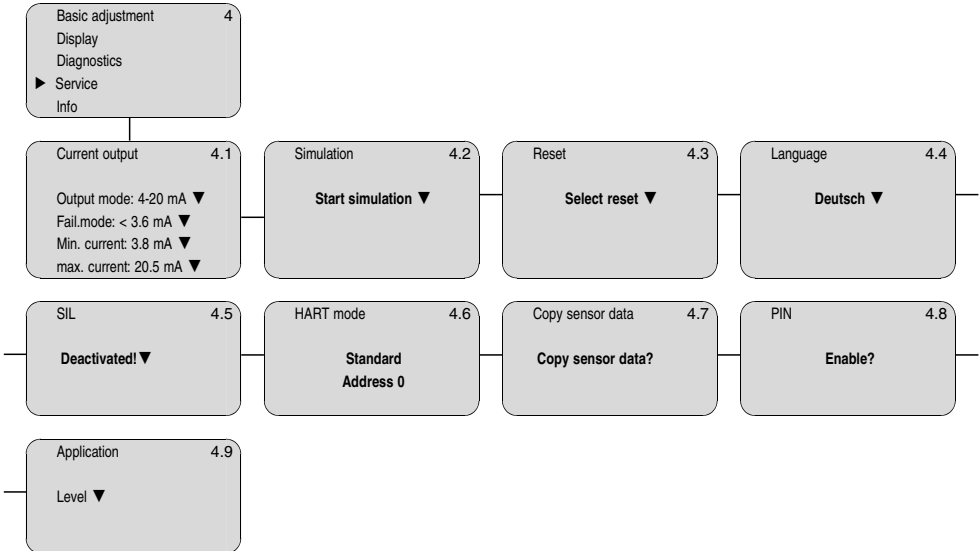

Info

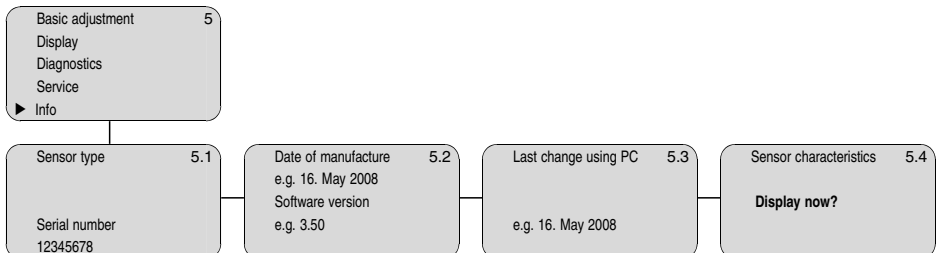

5.6 Menu schematic



Information:

Depending on the version and application, the highlighted menu windows are not always available.

Basic adjustment

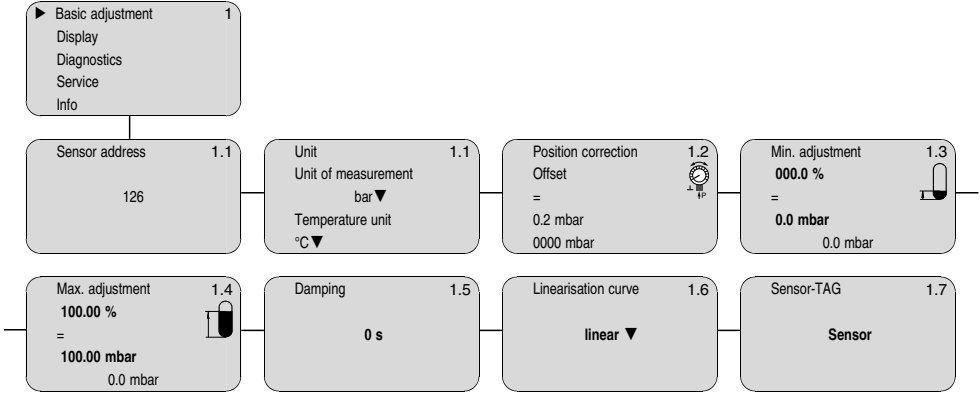

Display

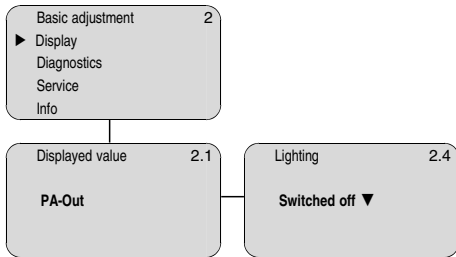

Diagnostics

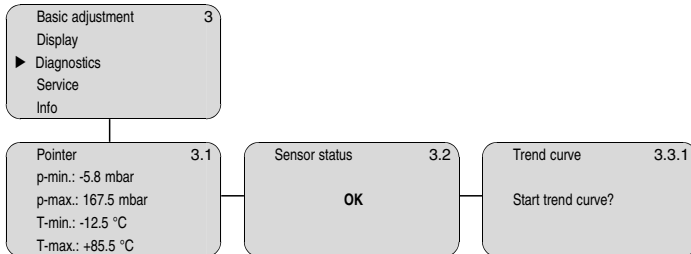

Service

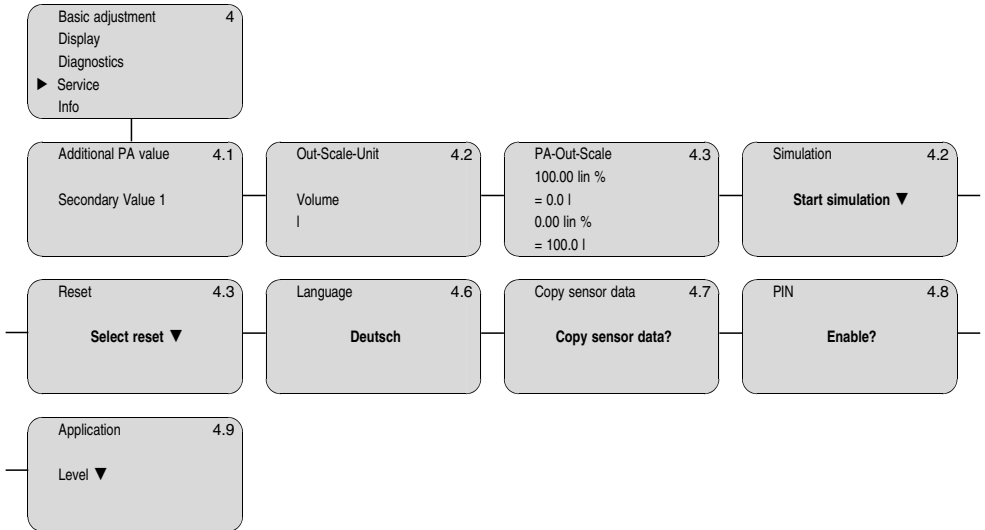

Info

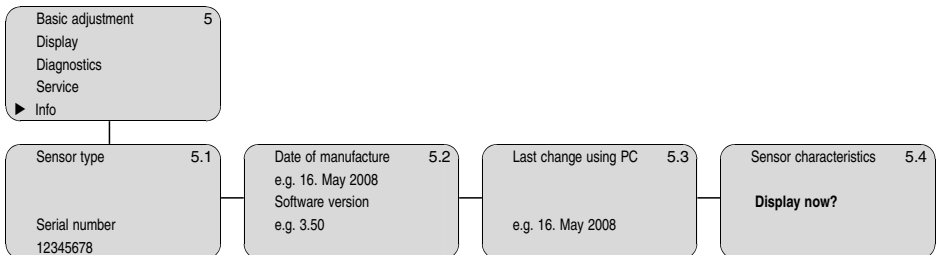

5.7 Menu schematic



Information:

Depending on the version and application, the highlighted menu windows are not always available.

Basic adjustment

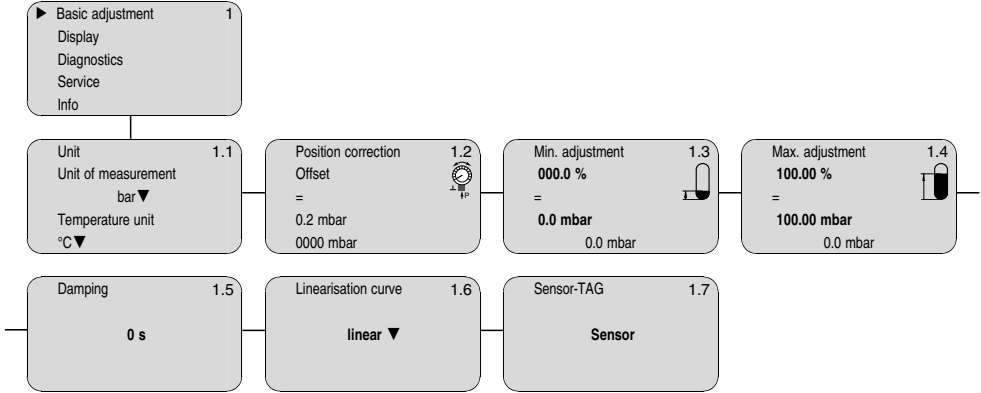

Display

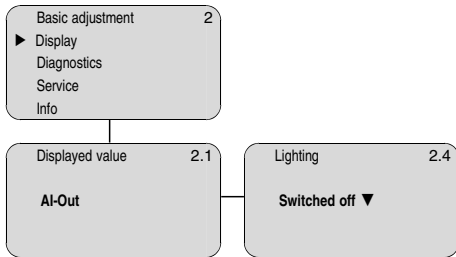

Diagnostics

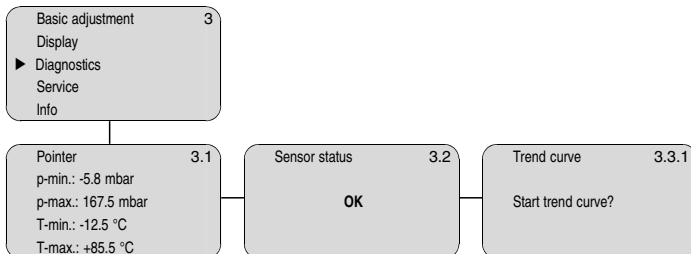

Service

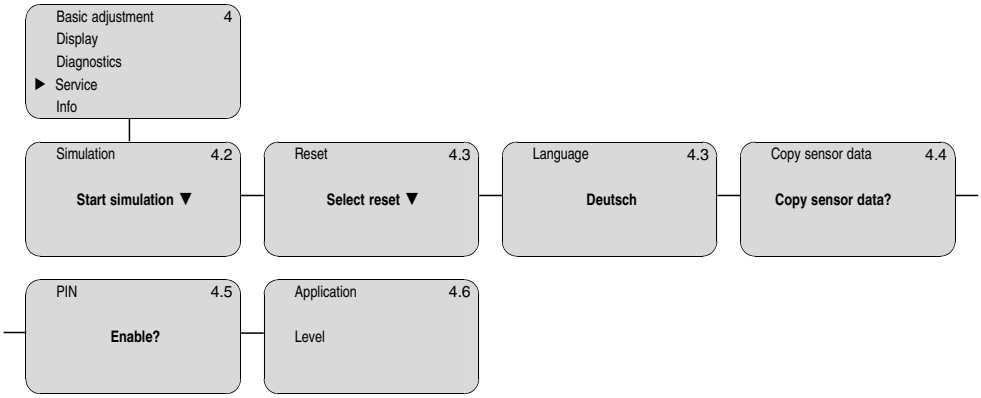

Info

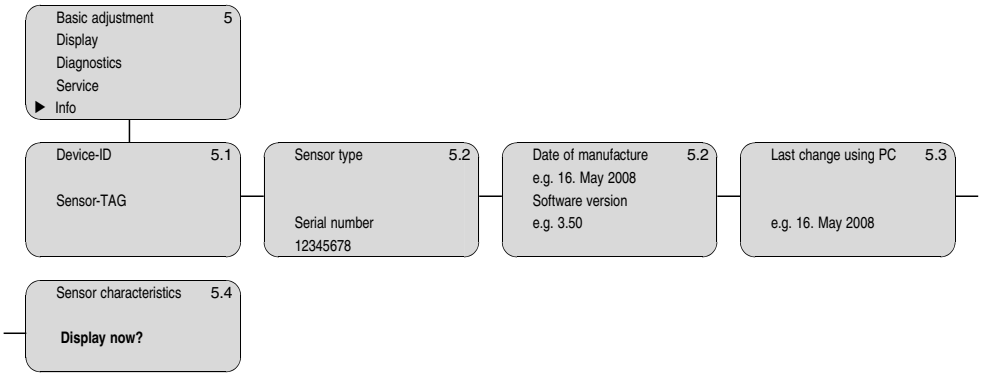

6 Maintenance and fault rectification

6.1 Maintenance

When used in the correct way, no special maintenance is required in normal operation.

6.2 Instrument repair

You can download a return form (24 KB) in the Internet from our homepage www.wika.com under the item "Service".

If a repair is necessary, please proceed as follows:

- Print and fill out one form per instrument
- If necessary, state a contamination
- Clean the instrument and pack it damage-proof
- Attach the completed form and probably a safety data sheet to the instrument
- Please contact the agency serving you for the address of the return shipment

By doing this you help us carry out the repair quickly and without having to call back for needed information.

7 Dismounting

7.1 Dismounting steps

**Warning:**

Before dismounting, be aware of dangerous process conditions such as e.g. pressure in the vessel, high temperatures, corrosive or toxic products etc.

Take note of chapters "*Mounting*" and "*Connecting to power supply*" and carry out the listed steps in reverse order.

7.2 Disposal

The indicating and adjustment module consists of materials which can be recycled by specialised recycling companies. We have purposely designed the components to be easily separable.

WEEE directive 2002/96/EG

This indicating and adjustment module is not subject to the WEEE directive 2002/96/EG and the respective national laws (in Germany, e. g. ElektroG). Pass the indicating and adjustment module directly on to a specialised recycling company and do not use the municipal collecting points. They may only be used for privately used products according to the WEEE directive.

Correct disposal avoids negative effects to persons and environment and ensures recycling of useful raw materials.

Materials: see chapter "*Technical data*"

If you have no possibility to dispose of the old instrument professionally, please contact us concerning return and disposal.

8 Supplement

8.1 Technical data

General data

Weight	approx. 150 g (0.33 lbs)
--------	--------------------------

Ambient conditions

Ambient temperature	-15 ... +70 °C (+5 ... +158 °F)
Storage and transport temperature	-40 ... +80 °C (-40 ... +176 °F)

Indicating and adjustment module

Voltage supply and data transmission	through the sensor
Indication	LC display in dot matrix
Adjustment elements	4 keys
Protection	
– unassembled	IP 20
– mounted into the sensor without cover	IP 40
Materials	
– Housing	ABS
– Inspection window	Polyester foil

8.2 Dimensions

Indicating and adjustment module

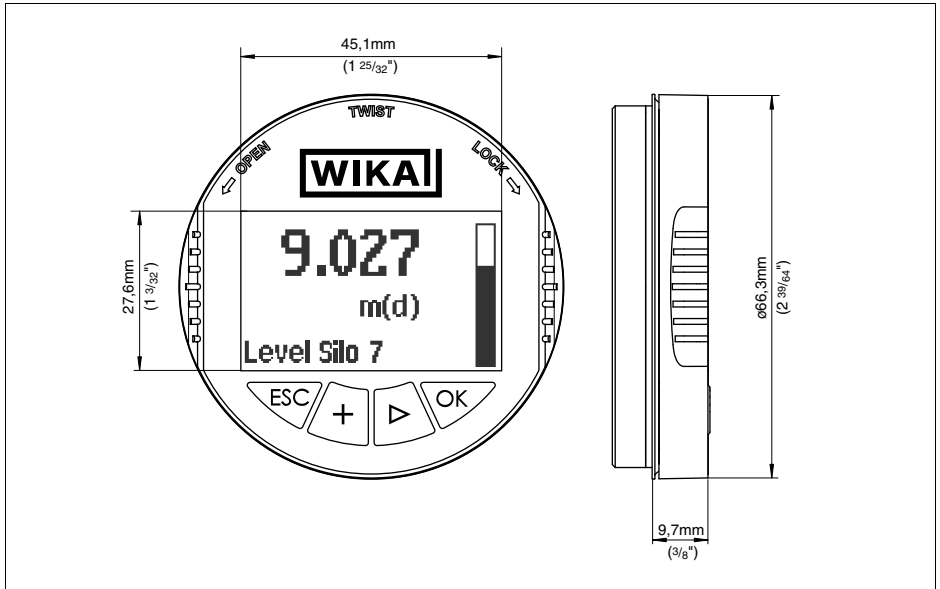

Fig. 5: Indicating and adjustment module

Printing date::



WIKAI Alexander Wiegand GmbH & Co. KG

Alexander-Wiegand-Straße 30

63911 Klingenberg/Germany

Phone +49 9372 132295

Fax +49 9372 132706

e-mail: support-tronic@wika.de

www.wika.de



All statements concerning scope of delivery, application, practical use and operating conditions of the sensors and processing systems correspond to the information available at the time of printing.